

European Clearing House
for Open Robotics Development
www.echord.info

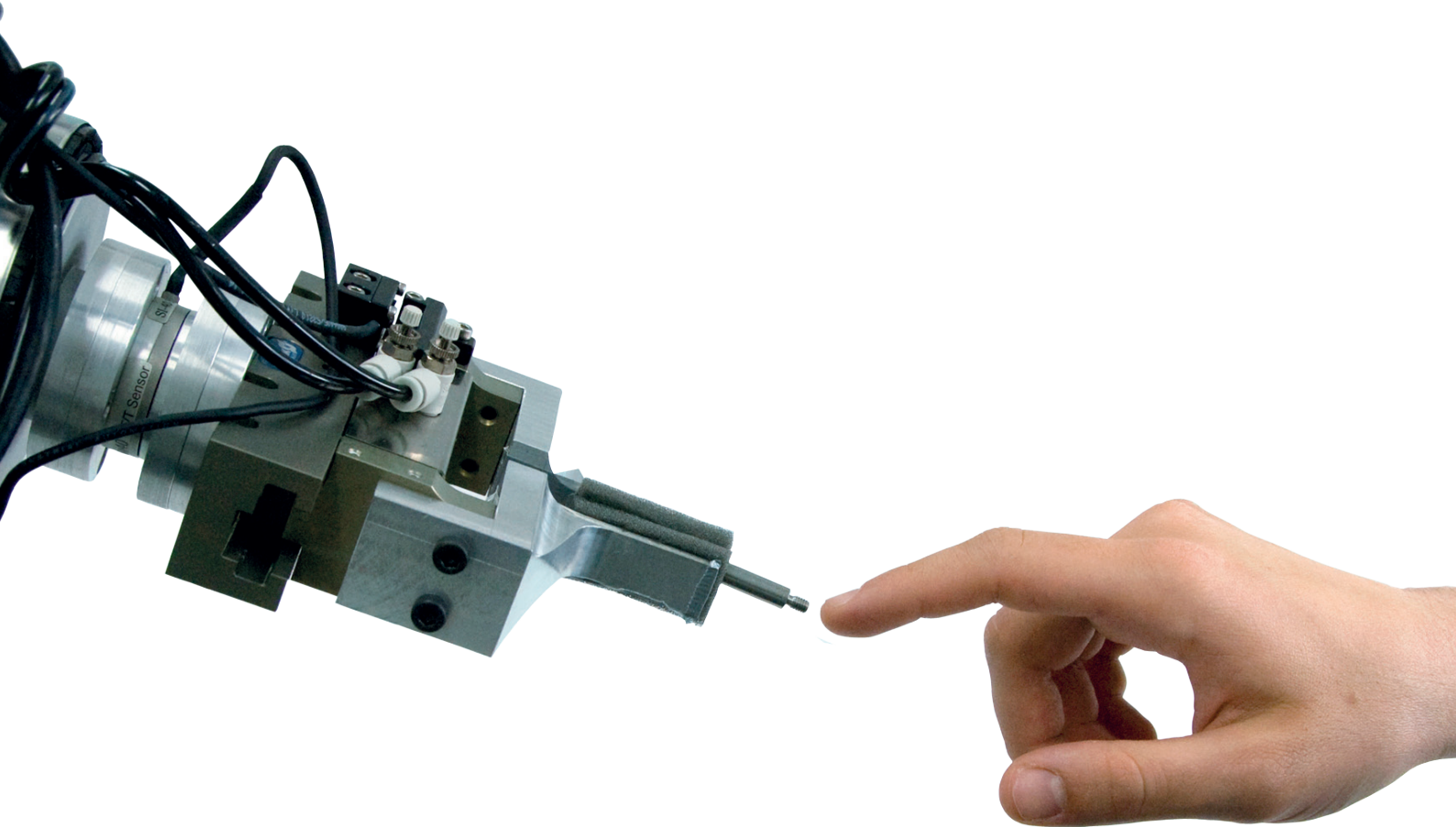

Robotic Equipment from European Companies



Products for Research Institutions



Technische Universität
München



Università di Napoli
Federico II



Universidade de
Coimbra



Preface

This brochure contains a comprehensive overview of European robotic products. Our aim is to achieve maximum coverage by continuously issuing expanded, up-to-date versions of this document. It was developed by the ECHORD project team, based on robotic equipment information gathered from a large number of companies and institutions. A description of each company is followed by its range of products, focusing on the overall features rather than on the details of technology. We expect this document to have significant impact on the robotic community — both researchers and manufacturers — by making it easier to find equipment needed for advanced research. We are confident that this document will be another bridge for new cooperations between industry and academia.

**Prof. Dr. Alois Knoll,
Dr. Christophe Simler, editors,
Technische Universität München (TUM)**

Table of Contents

Introduction.	7	ROBOSOFT SA60
List of companies:		ROBOX S.P.A.62
A3R S.r.l.	8	Rekno srl.64
ADEPT TECHNOLOGY10	ROBOTNIK AUTOMATION SLL.66
Aldebaran Robotics SA12	SCHUNK GmbH & Co. KG.69
BlueBotics SA14	SERTEC..72
Comau S.p.A.17	Skybotix AG73
Convergent Information Technologies GmbH.19	Stäubli Robotics74
Cyberbotics Ltd..20	Shadow Robot Company76
ELETRIC 80 S.P.A.21	Index78
FerRobotics Compliant Robot Technology GmbH.23	Publishing information.79
Festo Didactic GmbH & Co. KG25		
Fraunhofer IPA27		
Graal Tech Srl29		
GÜDEL AG31		
IBERBOTICS, S.L.33		
INGENIA-CAT, S.L.36		
KUKA Roboter GmbH39		
Kineo CAM.41		
Locomotec UG42		
m-BOT Solutions SL43		
M-Tecks EAC Sarl44		
Magellium45		
Merlin Systems Corp Ltd.46		
MetraLabs GmbH Neue Technologien und Systeme49		
NAV ON TIME52		
Neobotix GmbH54		
OC Robotics57		
qfix robotics GmbH59		

Introduction

The ECHORD project (European Clearing House for Open Robotics Development, FP7-ICT-231143, <http://www.echord.info>) is an innovative framework aiming at reducing the European robotic fragmentation by generating technological progress and by enhancing the knowledge transfer between robot manufacturers and research institutions. In order to realize this aim, about 50 small sub-projects (so-called experiments and having specific research foci and scenarios) with consortia composed of academia and industry are being carried out. This framework is a bridge

- providing new opportunities for coordinated and target-oriented scientific research as well as knowledge transfer in robotics,
- creating a productive collaboration environment for research institutions and robot manufacturers across Europe, and
- advancing key enabling (emerging) technologies in a bi-directional scientific exchange between research institutions and robot manufacturers.

This cooperation and the resulting knowledge transfer aims not only at reducing the fragmentation of European robotics industry. It also aims at providing our industry as a whole with tangible and measurable results by accelerating the development of new enabling technologies and by developing robotics technology for new applications. The European Robotics industry is set to gain a cutting edge advantage in an increasingly competitive world market.

A3R S.r.l.



Description of the company

A3R - Advanced Research is a young and dynamic company, founded in March 2008, born to develop new technologies and products related to mechatronics and unmanned systems.

The purpose of the company is to produce innovative and meaningful solutions in the field of UAS for military and emerging civil applications. A portfolio of UAS (Unmanned Aerial Systems) solutions, spanning from mini-micro UAS, light and small autopilots, flight and ground software, draw together the threads of the company's core capabilities to provide versatile, multi-purpose systems that are fit for modern operations.

A3R designs and sells small automatic pilots of the YAAP Family, specifically for mini and micro tactical UAVs using leading edge miniaturization and design techniques. The YAAP autopilot series is one of the world's smallest fully featured UAV autopilots series. A3R develops and sells user-friendly ground control software of the YACS Family with point and- click interface for mission planning, parameter adjustment, flight monitoring and mission simulation.

A3R also provides powerful target tracking, video stabilization and geo-location technologies. The company sells autopilots and ground control products to systems integrators and researchers within military, academic, defense industry and private research institutions, offering its expertise to customize applications to the customer needs.

**Via Enrico Ortolani, 102
00125 - Rome
Italy
<http://www.a3r.it>
+39 06 60513522
+39 06 99920546
m.digiamberardino@a3r.it**

Range of products

Autopilot YAAP Series

YAAP is a family of high performance autopilots made to allow autonomous flight of UAS with operational constraints. Their small size and reduced weight are especially suitable for mini and micro Unmanned Systems. Each autopilot contains cinematic and static sensors, as well as a dedicated Flight Software with an embedded Kalman Filter.

The main features are:

- Altitude hold, airspeed hold, waypoint navigation by means of GPS and sensor fusion Kalman filter.
- Waypoint management directly from GCS.
- Completely independent operation including autonomous take off and landing.
- 3-axis gyros, accelerometers, magnetometers, GPS receiver, pressure altimeter, pressure airspeed sensors, EPROM, dual processor, SD, all on a single circuit board.
- Control from 6 to 24 servos.
- Emergency status management.
- Full dead reckoning by means of a sensor fusion Kalman filter.
- Control system parameters configurable by means of a dedicated interface software.
- Multi UAV ready.



Complex setups with several components:

On Board Software Interface

The GNC Software architecture can be easily customized and the control parameters can be tuned by means of a dedicated interface software.

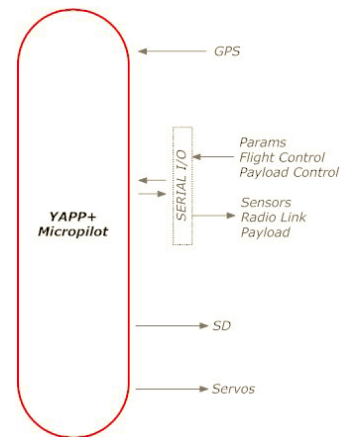
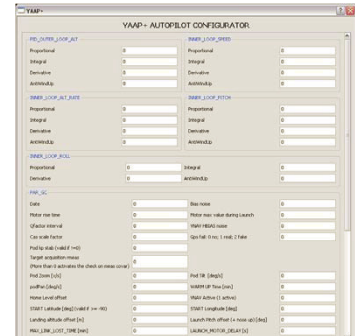

YACS Ground Control Station

YAAP autopilot can be easily connected to the YACS Core UAV Control Station (CUCS) software tool, designed to improve the inflight operations and to perform a better planning. It allows to have a complete control of an unmanned vehicle in all of its flight phases, from planning to landing.

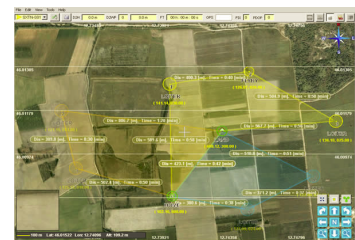

YASIM Flight Simulator

YACS Ground Control Station can be easily connected to the YASIM Simulator designed to quickly test the control and guidance algorithms or advanced vehicle mission capabilities. YASIM is thought and built to perform a detailed 3D view of the mission scenario with a complete description of the terrain elevations. In view of the mission training, YASIM Flight Simulator can be used to simulate the overall mission, moving the virtual camera as if it was the real on-vehicle POD.



ADEPT TECHNOLOGY



Description of the company

Adept is a global, leading provider of intelligent robots and autonomous mobile solutions and services that enables customers to achieve precision, speed, quality and productivity in their assembly, handling, packaging, testing, and logistical processes. With a comprehensive portfolio of high-performance motion controllers, application development software, vision-guidance technology and high-reliability robot mechanisms with autonomous capabilities, Adept provides specialized, cost-effective robotics systems and services to high-growth markets including Packaging, Medical, Disk Drive/Electronics, and Solar; as well as to traditional industrial markets including machine tool automation and automotive components.

Site d'Annecy
Parc Altaïs – 25, rue Véga
FR - 74650 Chavanod
<http://www.adept.com/>
<http://www.adept-technology.fr>
+33 450028116
info.fr@adept.com

Range of products

SCARA Robot- Adept Cobra s600/800

The Adept Cobra™ s600/800 SCARA robot (4-axis robot) is a high-performance SCARA robot system for mechanical assembly, material handling, packaging, machine tending, screw driving, and other applications that require fast and precise automation. Adept Cobra s-Series robots include the Adept SmartController™ motion controller, which provides excellent performance capabilities.



Six-Axis Robot – Adept Viper s650/850

The Adept Viper™ s650/850 six-axis robot is a high-performance articulated robot. The speed and precision of Adept Viper six-axis robots make them useful for material handling, packaging, machine tending, and many other operations requiring fast and precise automation. The Adept Viper™ s650/850 may be used with the open development environment Adept IDE (CIDE) described below as well as the standard Adept V+ language and OS.



Adept MT400 Platform

The Adept MT400 is an intelligent mobile robotic platform that combines the high payload capable mobile base with an onboard motivity controller and software for automatic map generation and guidance. The MT400 mobile platform with its interfaces and accessories can be used to deploy industrial applications that need flexible mobile automation.

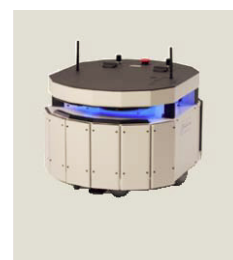

Adept ViperBot

The Adept ViperBot is an autonomous mobile 6 axis robot. It combines an Adept Viper s650 robot mounted on an Adept Mobile MT Platform.



Cerebellum Automation Integrated Development Environment (CIDE)

The CIDE is Cerebellum's main PC software. It is the interface to all of our products. It is used for configuration (setup of axis numbers, gains, limits, scale factors, time-outs...), diagnostic (verify cabling, motor rotation, torque, position, tracking, CPU usage...) and programming. The integrated editor and compiler allows for easy yet powerful programming of our products in C language. A well documented API (Application Programming Interface) gives access to all motion controls and vision functions needed to build a high end application. The software comes with ready-to-use examples for all major type of applications. After compilation, the user program is automatically downloaded to the servo node and the PC can be removed for production runs. For industrial vision, image acquisition and processing can be tested directly in the CIDE.

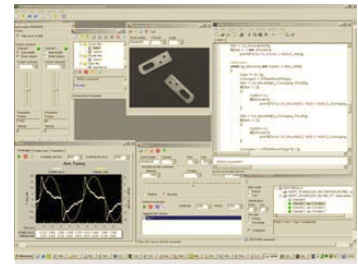

Cerebellum Automation Library (CALibrary)

The CALibrary is the API that enables the control of our products from your PC program. It is designed for .NET programming environment (Visual Basic, Visual C++, C# ...) but is also compatible with older versions such as VB6. It is used for controlling motors and robots as well as IO's from your PC program, building your custom user interface, and anything the CIDE can do but needs to be done in an automated way.

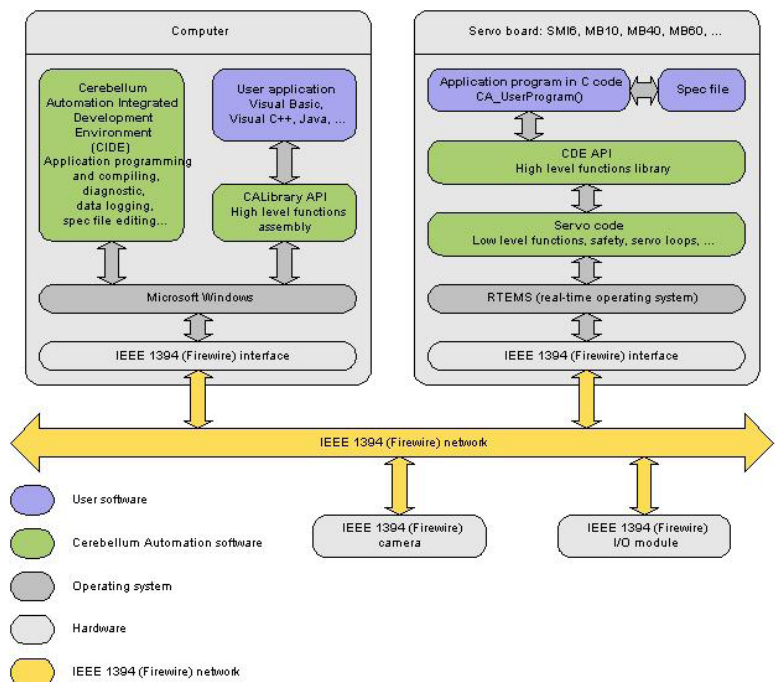

Aldebaran Robotics SA



Description of the company

Founded in 2005 by Bruno Maisonnier, and with offices in France, in China and in the United States, ALDEBARAN Robotics designs, produces and commercializes autonomous humanoid robots for the well-being of mankind. Today, over 1000 NAOs are utilized throughout the world as research and educational platforms in 30 countries. ALDEBARAN Robotics brings together more than 100 people—including 45 engineers and PhDs—that are involved in the development and production of the robots.

**168 bis – 170 rue Raymond
Losserand
75014 Paris
France
<http://www.aldebaran-robotics.com/>
+33 1 77 37 17 66
mduruy@aldebaran-robotics.com**

Range of products

Nao H25

NAOH25 is a trusted platform for education and research in various areas, from robotics and computer science to automation and human-robot interaction. NAOH25 is Aldebaran Robotics' most advanced robot. This fully-featured humanoid robot provides an open platform with full integration of state-of-the-art hardware and software. NAOH25 is robust, interactive and easy to use allowing you to focus on your core research.

Delivered with a set of well documented software, Nao is a powerful platform that can be programmed and controlled by expert researchers as well as beginner students. Its middleware architecture, NAOqi, allows algorithms to make their APIs available to others and helps prepare modules to be run either on NAO or on a remote PC. Code can be developed on Windows, Mac or Linux, and be called from many languages including C++, Python, Urbi and .Net. Aldebaran Robotics provides many modules built on this framework that offer rich APIs for interacting with NAO.

Choregraphe

Choregraphe user-friendly software enables users to easily program NAO. With Choregraphe and its flow diagram, you can explore event-based, sequential or parallel programming using a pre-programmed set of behavior boxes. Its timeline lets users program with a time scheduled logic. Pre-programmed behavior boxes are easily configurable, but you can also create your own, using the Curve Editor to edit movements, or writing them in Python script. Combining these three approaches opens huge possibilities to program NAO, with or without entering the complexity of code. Thanks to an ergonomic interface with the robot, executing behaviors on Nao developed within Choregraphe is just one click away.



SDK

SDK enables to embed modules into Nao and to use them, in order to create elaborate behaviors. SDK comes with the appropriate compilation and debugging tools. It is a cross-platform, compatible with many robotic development platforms and languages such as URBI, developed by Gostai, or .Net and the Microsoft Robotics Studio.

Complex setups with several components:

Laser Head

The NAO Laser head is equipped with a high-quality scanning range finder HOKUYO URG-04LX. Scanning Laser Range Finders are optimized sensors for environment recognition. High accuracy, high resolution and wide angle provide an excellent solution for autonomous robots moving in an unknown environment. This laser-equipped head is a very useful tool for scientists who want to explore research topics such as mapping, localization, autonomy, navigation and path-planning.



Our research is about humanoid robot navigation in complex indoor environments. That includes localization in a 3D environment, traversing multiple levels connected by stairs or ramps, and path planning in these environments. The image shows our laser-equipped NAO traversing some stairs in our experimental multilevel environment.



BlueBotics SA



Description of the company

BlueBotics SA aims at becoming world leader in autonomous navigation with the mission to enable the mobility of vehicles for the automation in the professional use market. The company is active in two segments:

- Automation – BlueBotics' core business is the navigation market, where the company offers ANT[®], its innovative navigation solution.
- Service Robotics – The Company offers R&D services with standard platforms, feasibility studies, custom designs and dedicated developments.

Parc Scientifique PSE-C
CH-1015 Lausanne
Switzerland
<http://www.bluebotics.com/com/>
+41 21 693 93 14
info@bluebotics.com

Range of products

ANT[®]

BlueBotics offers this navigation technology for a wide range of vehicles and robots.

- Fast, low cost, and scalable installation and modification: ANT[®] avoids any change to the navigation environment.
- Flexibility of movement: the vehicle autonomously handles obstacles and moves within a certain area to reach its goal instead of simply following a predefined line.
- Adaptability to new automation processes: ANT[®]'s fine positioning combined with its flexible movement allows to automate new processes (free pallet positioning, load transfer to trucks/wagons, deep stacking, etc.).

ANT[®] can literally be installed on any vehicle requiring indoor navigation such as autonomous guided vehicles (AGVs) for light and heavy transportation, mobile manipulators and any service robots.

AMV-1

The Autonomous Modular Vehicle is a mobility solution for rehabilitation centers and hospitals, and a logistics solution for light load industrial transportation. AMV-1 is in fact a mobile base, which can dock various modules. This system can be used to transport payloads up to 150 kg by means of dedicated modules, but can also transport persons with its specially designed ergonomic chair module. The AMV-1 base is of course delivered with ANT[®], our navigation technology.

Potential applications are:

- Displacement of patients in rehabilitation centers
- Distribution of food, drugs, etc. in hospitals
- Transportation of components for assembly lines
- Warehouse management based on furniture modules

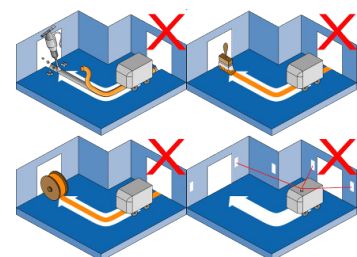
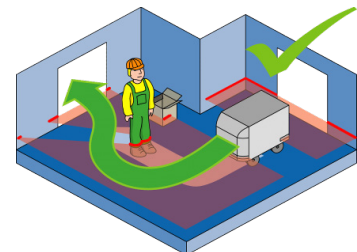

Today, BlueBotics proposes the AMV-1 base as a general transportation solution for light load logistics. With 150 kg payload, the vehicle can transport goods by means of its simple dedicated modules. For rehabilitation centers and hospitals, the AMV-1 is available with the chair module and can be used autonomously with the ANT® navigation under the control of the user or the ERP system, or even manually driven with a standard wheelchair joystick. Various transportation modules (food, drugs, etc.) are available on request.

Gilberto

Gilberto is our new entertainment robot. It is the result of the collaboration between Esatroll and BlueBotics. This Italian designed robot, equipped with ANT®, is now ready to serve you as robot guide, mobile information desk, etc.

Functions:

- Plays music and speaks English, French, German, and Italian.
- Interacts with the touch screen and provides web information.
- Knows where he is and where he has to go.
- Moves safely and smoothly around people and objects.
- Guarantees safety for humans and surrounding objects.

Designed by the Italian designer Gurioli, Gilberto is equipped with ANT®, like RoboX. Indeed, Gilberto shares most of its functionalities with his older brother RoboX. However, its communication and interaction capabilities are enhanced with a touch screen instead of four buttons. With an Italian design and Swiss technology, Gilberto is intended to work as a guide and information desk in airports, train stations, museums, exhibitions, trade fairs, and marketing events.



Shrimp III

With its ingenious mechanical structure, Shrimp III guarantees a very good mobility. It moves comfortably in all kind of challenging terrains, overcomes vertical obstacles up to twice its wheel size and it can climb stairs. The Shrimp III robot is a well adapted platform to develop new technologies for outdoor navigation and sensing. A passive structure is the key innovating factor of this robot: it does not need to actively sense obstacles for climbing them. Instead, it simply moves forward and lets its mechanical structure adapt to the terrain profile. With the result that the Shrimp III platform has no sensors or actuators, except motors inside the wheels controlled with speed regulators. Powered by 6 motors integrated inside the wheels and steered by two servos, this robot is able to turn on the spot. It is built in anodized Aluminum and it is equipped with modular electronics allowing the developer to communicate with it through a standard RS232 cable. It is an adapted platform to develop navigation solutions for challenging environments since only little calculation power is needed for the rover stability, most of it being naturally performed by the passive structure. Furthermore, Shrimp's performance can be tested in Webots, the fast prototyping and simulation software from Cyberbotics.



Atom

The Atom robot was designed for the robots@home® project realized in partnership with Otto Bock, Legrand and Nespresso. Its small size and friendly shape combined with the ANT® navigation system make Atom a suitable research platform for a wide range of indoor environments, such as homes or offices. Based on the company's mission of enabling the mobility for service robotics, BlueBotics has integrated the ANT® navigation into Atom. The performance of the navigation system, together with the flexibility and simplicity of installation renders Atom intuitive, safe and easy to deploy even by untrained end users.

Potential applications are:

- Autonomous light transportation
- Exploration and inspection
- Tour-guiding
- ... your own application!



Comau S.p.A.

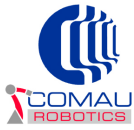

Description of the company

Comau Robotics is one of the worldwide leading manufacturers of high quality industrial robots. As a worldwide manufacturer of automatic flexible systems, Comau always played a prominent role in the evolution of Industrial Robotics. Its customers can choose from a large set of technologically advanced standard robotized solutions, which are the result of the continuous effort to meet customer requirements.

The satisfaction of our customers is always a top priority in Comau Robotics' strategy. A complete offer of services enables Customers to maximize performance during the whole life cycle of Comau Robotics' SMART solutions.

Robotics&Service Business Unit
Via Rivalta, 30
10095- Grugliasco (TO) – Italy
<http://www.comau.com>
+39 011/0045406
sales.robotics@comau.com

Range of products

SMART

SMART is the latest generation of Comau Robots: from 6 to 800 kg of payload with reduced overall dimensions, large working volume, high precision of movements and positioning accuracy; a constant innovation based on evolution in high technology, better performance, considerable reduction in power consumption, high reliability and low maintenance costs. Some examples of continuous improvement in innovation: high performance, reduction in cycle-time, complete observance of eco-compatibility and safety. Next generation of Robot Control Unit: the new C5G, compact design, free and ergonomic space for integration of all application functions, fast processing with Dual Core architecture, energy saving system able to reach high performance with minimum energy consumption. 2010 marks an important step forward for Comau Robotics, announcing the new entry in the Robot Family Range of SMART5 PAL, the innovative robot designed for palletizing operations, managed by new Control Unit C5G and Wireless Teach Pendant.

Smart Robots – Low & Medium Payload: SMART SiX - SMART NS - SMART NM

With payloads from 6 to 45 kg, models typically used for arc-welding, machine tool tending, assembly, manipulating, sealing and polishing applications. These robot families feature high repeatability (up to 0.05 mm) and are suitable for applications requiring the highest speed and precision.



Smart Robots - High Payload: SMART NJ

With a payload from 110 to 500 kg, these models represent the state of the art in mechanical design, offering good performance in terms of speed, robustness, reliability and precision. The innovative but long established “hollow wrist” technology has been further enhanced by the SMART NJ4 models: their entire welding dressing is housed in the forearm rather than externally.



SMART5 PAL

2010 marks an important step forward for Comau Robotics, announcing the new entry in the Robot Family Range of SMART5 PAL, the innovative robot designed for palletizing operations, managed by the new Control Unit C5G and Wireless Teach Pendant. Range from 180 to 260 kg payload and 3.1 m reach, hollow wrist technology and mechanical options shared with the entire Robot Family product range; overall reduced weight, high speed performance for reduced and optimized cycle-time, ergonomic and top-class design with carbon fibre rod: the new innovative robot will meet customer requirements and high quality demands in industry in general, mainly in loading/unloading applications, multiple products pick up, palletizing and high speed operations.



C4G open controller

The C4G open controller is adequate for universities and research centres. It is an efficient industrial robot platform for experiments with sensors (force, cameras, controlled at 1 msec).

Extended Open C4G architecture



- In the extended open C4G architecture the external Personal Computer is managing a complex environment with external sensors/devices to achieve very complex application implementation.
- The hard real time Open C4G environment can be extended with the “PDL2 RD/RW TCP/IP” option to allow extended command and synchronization between PDL2 programs and the additional SW logic implemented in the PC. External sensors/devices can further enhance application capabilities.

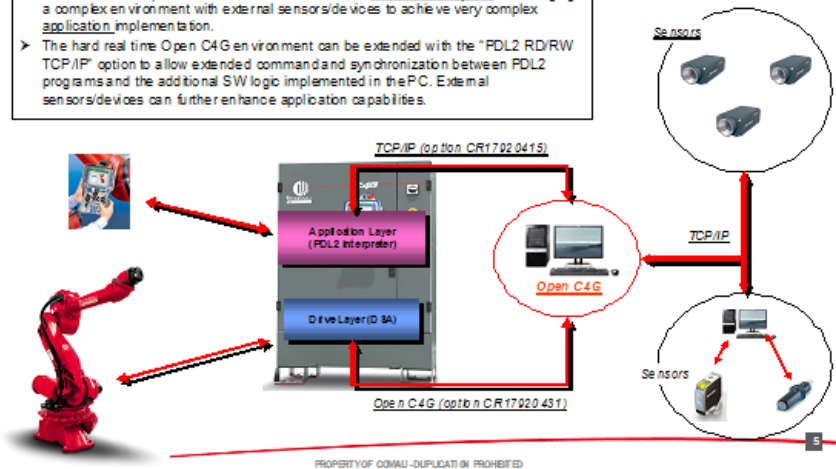

Convergent Information Technologies GmbH



Description of the company

Convergent Information Technologies is a startup software company located in Steyr, Austria. Software tools and software systems are developed in order to make robots adaptive and to program them fully or semi-automatically - up to 100-times faster than conventionally even without robot experts.

**Im Stadtgut A1
4407 Steyr-Gleink
Austria
<http://www.convergent-it.at>
+43 -681 107 22 671
ce@convergent-it.at**

Range of products

AutomAPPPS

AutomAPPPS (Automated Application and Process Planning Programming and Simulation) is a SW for fully or semi-automated programming of processes AND robots – with embedded process models. Applications include (but are not limited to):

1. inspection of chassis and other parts
2. cleaning of chassis and other parts
3. marking (defects etc.) of chassis
4. polishing of parts
5. grinding of parts

Variants include:

1. Off-line SW tool for rapid planning and programming robots and process - fully or semi- automated
2. On-line planning and programming of processes and robots – fully automated
3. Reactive on-line planning and programming of processes and robots.

Motion planning modules are also offered stand-alone for automated robot motion planning featuring, for example multi-robot planning, speed-bound and state-x-time planning, a.s.o.

AutomAPPPS, version adapted for advanced research

Specific variants of our automated process and robot programming solutions which specifically support faster advancements in project's core topics are provided to researchers:

1. Version of AutomAPPPS for dynamic scenes
2. Customizing of AutomAPPPS interfaces, functions to individual needs of research projects that allow for fast realization of automated programming e.g. in service applications
3. Version of AutomAPPPS to especially investigate and implement researchers own novel processes within the AutomAPPPS planning tool

There are specific variants or packages of our motion planning for researchers that support faster progress in the core areas of the projects:

1. Dynamic-planner version for dynamic scenes and moving parts
2. Linux version
3. Customizing of interfaces or functionalities to individual needs of R+D projects which allow for a faster realization in service applications
4. Customizing to support specific kinematics

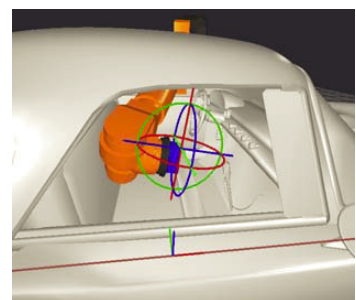
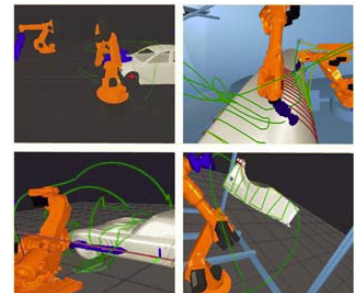

Cyberbotics Ltd.



CYBERBOTICS
professional mobile robot simulation

Description of the company

Cyberbotics is a leading company in mobile robot prototyping and simulation software. It develops and markets Webots, the award winning fast prototyping and simulation software for mobile robotics. Developed since 1996, Webots has become a reference software used by over 800 universities and research centers worldwide. Cyberbotics also develops custom simulation models like the Aibo model which was developed for Sony Corp. or the Nao models currently used by participants to the RoboCup SPL competition.

Additionally, Cyberbotics participates in a number of European research projects as an SME partner. These include the FP6-IP ICEA project and the FP7-IP RHEA project.

PSE C – EPFL
CH-1015 Lausanne
Switzerland
<http://www.cyberbotics.com>
+41 21 693 86 24
info@cyberbotics.com

Range of products

Webots

Webots is a development environment used to model, program and simulate mobile robots. With Webots the user can design complex robotic setups, with one or several, similar or different robots, in a shared environment. The properties of each object, such as shape, color, texture, mass, friction, etc., are chosen by the user. A large choice of simulated sensors and actuators is available to equip each robot. The robot controllers can be programmed with the built-in IDE or with third party development environments. The robot behavior can be tested in physically realistic worlds. The controller programs can optionally be transferred to commercially available real robots. Webots is used by over 800 universities and research centers worldwide. With Webots, you take advantage of a proven technology that has been co-developed by the Swiss Federal Institute of Technology in Lausanne, tested, documented and continuously maintained.

The main features are:

- Models and simulates any mobile robots, including wheeled, legged and flying robots
- Includes a complete library of sensors and actuators
- Has a built-in 3D world and robot editor with VRML import capability
- Lets you program the robots in C/C++, Java, Python, URBI™, MATLAB™ or interface with third party software through TCP/IP
- Supports multiple platforms including Windows, Mac OS X and Linux
- Uses the ODE (Open Dynamics Engine) library for accurate physics simulation
- Transfers controllers to real mobile robots, including e-puck™, Nao™, Katana™, Hoap-2™, etc.
- Creates AVI or MPEG movies of your simulations for the web or for public presentations
- Includes world examples with controller source code and models of commercially available robots
- Simulate multi-agent systems, with communication facilities
- Comes with a commercial user support

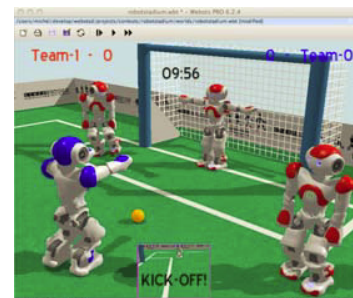
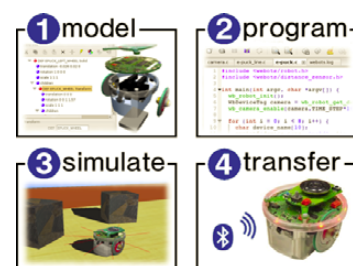
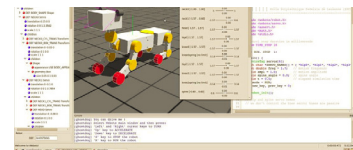

ELETTRIC 80 S.P.A



Description of the company

Elettric 80 is a global provider of end-of-line automation solutions which increase operational profitability and efficiency. Our technology helps companies cut cost and move product out of the plant in a fast and effective manner.

Our proposition is based on Freeway® - a highly flexible material handling system which utilises palletising robots, Automated Guided Vehicles (AGVs), Laser Guided Vehicles (LGVs), high speed stretch wrappers (Silkworm) and a pallet control system. The entire process is managed centrally by a state-of-the-art Warehouse Management System (WMS).

<http://www.elettric80.it>
+39 0522 762011
elettric80@elettric80.it

Range of products

LGVs/AGVs – Laser Guided Vehicles

A LGV / AGV - Automated Guided Vehicle physically moves the goods and acts as the link between the different machines within the warehouse environment. The vehicle combines many different systems to ensure reliability and efficiency, including Energy, Safety, Fork/Load Handling and Guidance and Control systems.

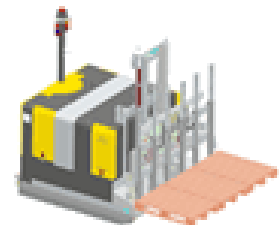

Palletising Systems

Elettric 80 has a range of palletising robots that cover most of the robot palletising needs in a modern production unit. All robots are based on Fanuc Technology (motors and drives) and can incorporate Fanuc Robot arms when applicable. Over the years, the combination of Elettric 80 engineering and Fanuc Robot Technology has provided our customers with unparalleled levels of flexibility and service. Robot palletisers have proven to provide greater flexibility to the palletising function when compared to traditional layer palletisers. This flexibility in conjunction with high reliability and low maintenance costs has been the main reason why Elettric 80 has focused purely on Robot palletisers.



Automated Guided Vehicles

A LGV / AGV - Automated Guided Vehicle physically moves the goods and acts as the link between the different machines in the warehouse environment.

The Freeway® System contains software for scheduling, routing, monitoring and visualization of the complete end-of-line process.

The Elettric 80 vehicles are based as much as possible on commercial standard components (Siemens, Allan Bradley etc) and state of the art technology. This gives the user a reliable product with good local support and with the benefit of second sources of spares. Elettric 80 constantly monitors the market for the latest and most relevant new technologies to add to our vehicles. The list below shows some examples of this.



- AC drives= No maintenance
- PC Controls= Easy access
- CAN Bus= Easy diagnostics
- Industrial Terminal= Easy to use

Applications: Beverage, Food, Tissue and Various
 Elettric 80 has a long experience of making tailor-made applications for the end-of-line sector in the beverage, food and tissue sectors as well as other industries. The vehicle combines many different systems to ensure reliability and efficiency, including Energy, Safety, Fork/Load Handling and Guidance and Control systems. Each AGV has to localize itself within the warehouse environment. Several reflectors are distributed in the environment and the AGV localizes itself by integrating the odometry data, coming from the encoders, with the data measured by a laser scanner, placed on the top of each vehicle.

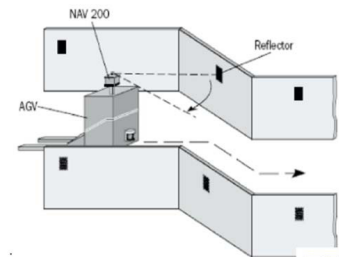

The purpose of an LGV obstacle detection system is to detect any obstacle on the path, in time, so that the LGV can slow down and stop, if necessary - until the path is clear. As the path clears, the LGVs will automatically continue their trip.

The actual charging can be done preferably with an automatic battery exchange system or with automatic charging. The extreme load handling flexibility of the LGVs depends mainly on the sophisticated fork movements. Each fork can be adjusted automatically to handle different pallet types and even search for the pallet using laser scanners mounted on the vehicle. A tilt function on the fork package assures a high safety level when driving and loading pallets in a storage.



The overall control system for the fleet of AGVs is made up of three layers. The two higher layers are centralized, while the third is executed asynchronously on each vehicle. At plant level, the incoming transportation requests are collected from the flexible manufacturing system. The mission manager is responsible for defining the sequence in which the missions have to be passed to the traffic management system so as to be executed by the AGVs. The fleet level where the traffic management system is located, monitors the status of the fleet and incrementally determines the trajectory segments which are reserved to any AGV in order to efficiently execute the transports while avoiding collisions with other vehicles.

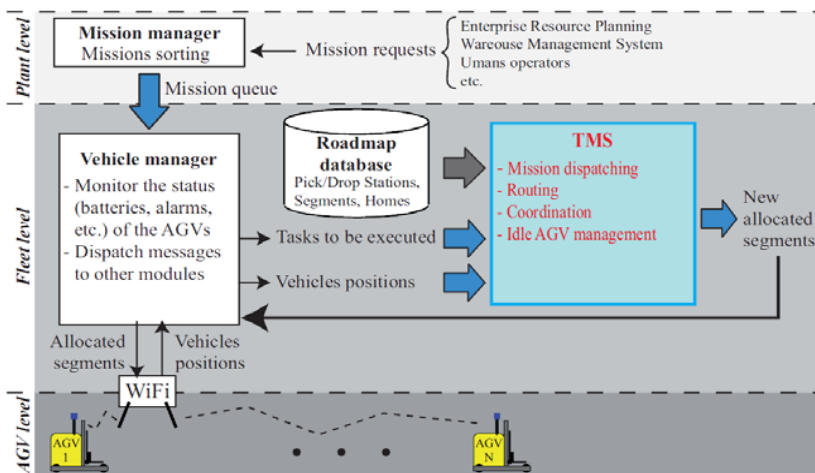

FerRobotics Compliant Robot Technology GmbH



Description of the company

The FerRobotics Compliant Robot Technology GmbH is a worldwide leader in developing sensitive, physically compliant robots. FerRobotics robots perform sensitive, force controlled and self-regulated touch, comparable to the human sense of touch. Core competencies are automation sequences or any kind of human related tasks with an extremely high degree of touch sensitivity, complexity and control required.

The FerRobotics compliant robot technology masters handcraft operations easily, nestles into existing automation setups smoothly and thus closes the still existing gaps in automation.

Altenbergerstr. 69
4040 Linz
Austria
<http://www.ferrobotics.at>
+43 720 10810701
paolo.ferrara@ferrobotics.at

Range of products

Active Contact Flange ACF110, ACF120 (contact sensitive, self-regulated equipment for stiff standard robots)

Robots need a sense of feel and get it with a new, controlled contact element. This active contact flange is a combined actuator and sensor element between the robot and its tools. Equipped with a standard flange, it is suitable for all automated solutions. These active components make the robot touch-sensitive. Many applications that have been manual so far can be automated easily and efficiently with the active contact flange.

This active contact flange is touch sensitive and force regulated because it is an actuator and sensor in one. It compensates for tolerances with its own dynamic control. The pre-programmed robotic tracks are not affected by tolerances at the work pieces and at the tools. The simple pre-setting for the forces makes it extremely flexible to implement. This tuning kit is especially optimized for the wide application range of surface treatments (grinding, polishing, laminating,...) and contact-sensitive handling (such as assembling, inserting, packing,...) providing an applicable contact force from -90 N up to +500 N. This pneumatic technology considerably reduces the risk of damage in the event of collisions. Even shocks and jolts are cushioned by the system.

Complex setups - System integration:

The integration uses digital signals or standard field bus systems. This leaves all possibilities open and the controlled flange works in your applications. The active contact flange sends the contact situation, position and force to your application. Your system can react quickly and flexibly. Process and quality controls are conveyed automatically.



ROMO (Lightweight Robot Arm)

ROMO is a pneumatically driven robot with integrated force measurement. ROMO tactually recognizes occurring resistance and applies its force automatically. This new technology now makes positioning on contact with a definable contact force possible. Quick and easy conversion is guaranteed by the integrated show-do programming. According to the motto "show-record-do", ROMO reduces changeover time. 7 degrees of freedom comparable to a human arm carry out individual and changing tasks or even complex job routines. Mobile and space saving ROMO's lightweight construction has been designed to operate at different workplaces. Therefore, even one single person can easily set it up in different work places.



OB Service Hand

Acknowledged in prosthetics and robotics, this tool helps and does a useful job in any human environment. The surface feels like skin, it looks appealingly human and it grasps with precision.

The main features are:

- Human like grasp
- Force controlled take effect (pick force 100 N)
- Force sensor and slip sensor
- Firm and gentle performance
- Light weight construction (min. 86 g)



Festo Didactic GmbH & Co. KG



Description of the company

Festo Didactic has developed into a leading company in the field of industrial training and industry-oriented vocational education. It develops solutions which enhance learning success and productivity across the entire spectrum of production and technologies applied. Festo Didactic is present in more than 100 countries around the world. The Learning System for Automation includes current topics in technical education in Festo's product ranges: pneumatics, hydraulics, electronics, electrical engineering, sensors, robotics, CNC technology, PLC and fieldbus technology, manufacturing technology and process engineering as well as mechatronics.

Rechbergstr. 3
D-73770 Denkendorf
<http://www.festo-didactic.com>
+49 711 3467-0
did@de.festo.com

Range of products

MPS® - The Modular Production System - Robot Station (Learning System)

The Robot station can transport workpieces that are fed in via a slide and place them in an assembly retainer. The sensor in the gripper enables the robot to differentiate workpieces by colour (black/non-black). The sensor in the assembly retainer monitors the orientation of the workpiece. From the assembly retainer the robot sorts the workpieces into various magazines or passes them on to the downstream station. Combination with the assembly station facilitates the assembly of workpieces.

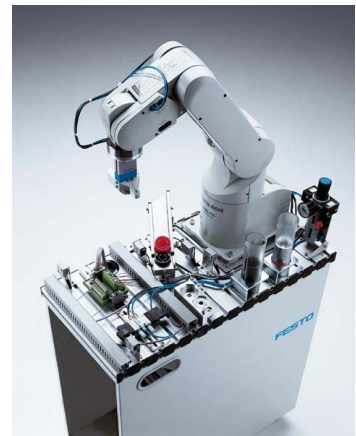

MPS® - The Modular Production System - MPS® 202-Robotics (Learning System)

Robot systems are far from easy to assemble and dismantle, transport and commission, but represent a highly interesting topic when it comes to training. The robot performs precision assembly of pistons and springs. The new Drive Unit for the RV-2SDB is small, powerful and lightweight – and fits into the MPS® trolley. With Drive Unit and Teachbox, the system is completely equipped straight from the box. Digital I/Os already contained in the system are used to control all the modules such as the cap and spring magazines.

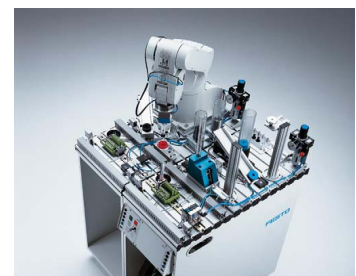

PmicroFMS MR6 - Milling cell with robot loading (Learning System)

MILL 55 is a 3-axis milling machine with an industry-compatible design that facilitates all machining possibilities of a modern CNC milling machine: milling, cutting and drilling/boring.

The automatic control and loading/unloading of the CNC machine is undertaken by the 6-axis RV-2SDB industrial robot used in the MPS®. In the parts buffer station, cylindrical unmachined parts are buffered and separately fed to a robot for removal. After CNC machining, the robot removes the finished part and places it on the station's other conveyor belt, where it is either buffered or separated for further transport.



MicroFMS TR6 - Turned parts with robot loading (Learning System)

TURN 55 is an industry-compatible inclined-bed lathe that facilitates all machining possibilities of a modern CNC lathe: turning, plunge cutting, cropping and drilling. The automatic control and loading/unloading of the CNC machine is undertaken by the 6-axis RV-2SDB industrial robot used in the MPS®. In the parts buffer station, cylindrical unmachined parts are buffered and separately fed to a robot for removal. After CNC machining, the robot removes the finished part and places it on the station's other conveyor belt, where it is either buffered or separated for further transport.



MicroFMS MTLR11 – Turning and milling with robot on linear axis (Learning System)

This combination of TURN 105 and MILL 105 facilitates an efficient implementation of a CNC machine production line for turning and milling operations. Automatic control and loading/unloading of the CNC machine is undertaken by a 6-axis RV-2SDB industrial robot that travels on a linear axis. Unmachined parts are fed to the first production process via 2 conveyors. This facilitates feeding of two different unmachined parts, for example aluminium and brass. The workpieces undergo turning and milling in sequence and are then placed on the third conveyor.



Robotino® (Learning System & Research Equipment)

Robotino® the mobile mechatronic learning system guarantees rapid success, giving you the necessary confidence and motivation to address complex problems. Robotino® is ready for use straight away. There's no lengthy setting up, and no writing or compiling programs. All it takes is a push of a button, and Robotino® is in action. Select your demo application and Robotino® moves autonomously. Robotino® has all the necessary interfaces for easy integration of sensors, self-built add-ons or the like. With a graphical programming and learning environment Robotino® View, the interactive graphical programming and learning environment, communicates via Wireless LAN directly with the robot system, with no compiling or downloading to the controller.



The main features are:

- Sensor technology
- Drive technology
- Motor control
- Closed-loop control technology
- Mechatronics
- Programming (symbolic/C++)
- Vision system
- Function testing, troubleshooting
- Transmission functions of controlled systems
- Digital and analogue signal processing
- Program simulation, troubleshooting, error analysis
- Plant safety in respect of hardware and programming
- Speed adjustment, position control - controller parameter setting
- Kinetics

Fraunhofer IPA



Description of the company

The Fraunhofer-Gesellschaft (www.fraunhofer.de) undertakes applied research, which is of direct use for private and public enterprises and of wide benefit to society. Its services are solicited by customers and contractual partners in industry, the services sector and public administration. The Fraunhofer Institute for Manufacturing Engineering and Automation IPA develops solutions for organizational and technological functions in the production sector of industrial companies. The activities conducted by the Robotic Systems department (www.ipa.fraunhofer.de/robotersysteme) encompass all areas connected with robot deployment and automatable production processes, as well as the development of robotic systems and their key components. Many of Fraunhofer IPA's technologies and solutions have already proved their worth in daily use.

Fraunhofer IPA is well known for the development of highly sophisticated hardware platforms suitable for everyday use such as the robotic home assistant Care-O-bot® (www.care-o-bot.de) or their three entertainment robots which have been moving freely among visitors of the "Museum für Kommunikation" Berlin for more than 10 years.

**Nobelstrasse 12
70569 Stuttgart
Germany
<http://www.care-o-bot-research.org/>
+49 711 970-1330
ulrich.reiser@ipa.fraunhofer.de**

Range of products

Care-O-bot® 3 (Mobile Manipulation Platform)

Care-O-bot® 3 delivers a robust and reliable hardware platform that is suitable as a testing and validation platform for addressing current issues in the field of robotics research. The Care-O-bot® 3 hardware setup includes in total 28 DOF. The main components of the robot are its mobile base, torso, manipulator, tray and sensor carrier with sensors. The robot is driven by four wheels, whereby each wheel's orientation and rotational speed can be set individually. This provides the robot with an omnidirectional drive enabling advanced movements and simple complete kinematic chain (platform-manipulator-gripper) control. The base also includes the Li-Io battery pack (50V, 60 Ah), laser scanners and a PC for navigation tasks. The size of the base is mainly defined by the required battery space. Nevertheless, the maximal footprint of the robot is approx. 600 mm x 600 mm and the height of the base is approx. 340 mm.

The torso sits on the base and supports the sensor carrier, manipulator and tray. It contains most of the electronics and PCs necessary for robot control. The base and torso together have a height of 770 mm. The manipulator is based on the Schunk LWA3, a 7-DOF light-weight arm (see the illustration on the next page). It has been extended by 120 mm to increase the work area so that the gripper can reach the floor, but also a kitchen cupboard. Special attention was paid to the mounting of the arm on the robot torso. The result is based on simulations for finding the ideal work space covering the robot's tray, the floor and area directly behind the robot.



Since the manipulator has a hollow shaft no external cables are needed. A slim quick-change system allows attaching different grippers, robotic hands or other tools to the arm. The 7-DOF Schunk Dexterous-Hand has tactile sensors in its fingers which make advanced gripping possible. The robot has a sensor carrier with high-resolution stereo vision cameras and 3D-TOF-camera. The sensors are mounted on a 5-DOF positioning unit allowing the robot to direct the sensors to any area of interest, but also to gesture by body movement.

When using Care-O-bot® 3 for demonstration purposes or user studies, flexible casings are available, with a design which is user-oriented and similar to the intended product.

Complex setups with several components:

Control software

Open-source software for Care-O-bot® 3 is available for free on www.care-o-bot-research.org. Currently, the drivers for all hardware components along with simulation and visualisations are available free of charge based on ROS (see www.ros.org/wiki/care-o-bot).

Hardware setup

The hardware setup of Care-O-bot® 3 is completely modular. For example, it is possible to integrate different arms (e.g. a Kuka lightweight arm has already been integrated) or sensors (e.g. Microsoft Kinect) in the sensor head. Due to the use of standardized interfaces in ROS, existing software components may be transferred to the Care-O-bot® control software easily.

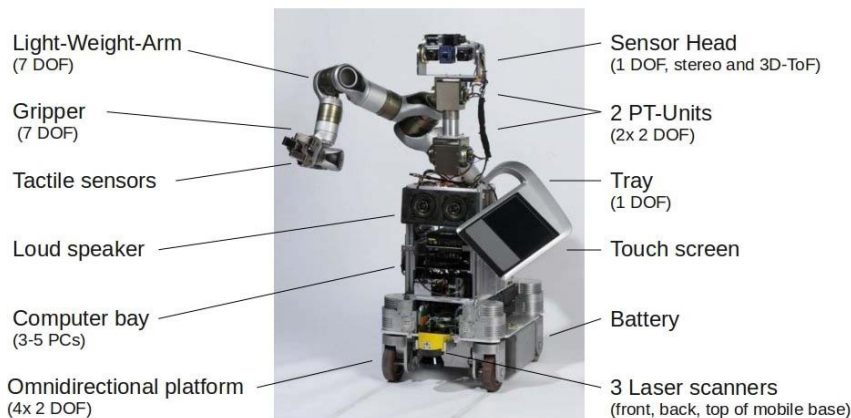

Graal Tech Srl



Description of the company

Graal Tech is a Research and Consultancy SME working in the fields of automation, underwater robotics, control system design, instrumentation and electromechanical engineering. The Company's mission is to provide innovative electromechanical devices responding to customer demands, thanks both to a team of diversified Senior Engineers and to the expertise in adopting a multi-disciplinary approach to problems. It was established in 1998 as a spin off company from DIST (Department of Communication, Computer and Systems Sciences, University of Genoa). In the course of the years, Graal Tech grew more and more industrial, even if a strong link with academic and research environments has always been preserved. The strong experience gathered during years of successful EU-funded research projects and the continuous and fruitful collaborations with prestigious research institutions like NURC (Nato Underwater Research Center) and ISME (Italian Interuniversity Center for Integrated Systems for Marine Environment) led Graal Tech to set up a sector specialized in providing intelligent systems for marine applications, which is currently the main field of activities of the company.

Via Ruffini 9R
16128 Genova
Italy
<http://www.graaltech.it>
+39 (0)10 8597680
alessio.turetta@graaltech.it

Range of products

eFOLAGA, eFOLAGA+

eFOLAGA and eFOLAGA+ are smart and compact Autonomous Underwater Vehicles (AUVs) capable of carrying different kind of sensors. With a length of 2 m, a diameter of 0.15 m and a dry weight of 31 kg, they can dive vertically up to 80 m and can even navigate in a low-power consuming mode, as a glider, thanks to ballasting and weight displacement capabilities. Originally designed for applications related with environmental monitoring, they currently make also missions possible concerning inspection and security activities, thanks to their greater maneuverability, empowered operative autonomy, and ease of integration of different kinds of payload modules.



Among the main distinctive features of both eFOLAGA and eFOLAGA+ is the possibility of mounting, in the easiest possible way, different kinds of mission payloads, avoiding the need for re-calibrating the vehicle control system whenever a change in the payload occurs. The AUV is made up of two independent modules, each one neutrally buoyant and balanced by itself. Any custom or COTS device may therefore be encapsulated inside an additional neutral and balanced payload module.



A side-scan sonar module has been recently developed on behalf of NURC (Nato Underwater Research Center) and has been delivered together with a set of 5 eFOLAGAs. Two other modules (one hosting a DVL and an IMU, the other with a camera head) are currently under development for other customers. Any other customized payload module can be realized on demand.

eFOLAGA+ is based on the same concept as eFOLAGA and differs from it because of the hovering capability, only available, up to now, on much larger vehicles. It is obtained thanks to the presence of 8 jet-pumps (in lieu of the 4 available on eFOLAGA), located in a symmetric configuration, 4 lateral (2 pointing to the left and 2 pointing to the right) and 4 vertical (2 pointing downward and 2 pointing upward).

The absence of steering control surfaces allows eFOLAGA+ to perform fine maneuvers even on position, without requiring hydrodynamic lifts. The four vertical pumps make any vertical translation more reactive and allow a more accurate attitude trim (when used in combination with the buoyancy and attitude controls); the four horizontal pumps enable the vehicles to perform lateral translation and allow the vehicle to turn on the spot.

Complex setups with several components:

Hardware

Both eFOLAGA and eFOLAGA+ are ready-to-use equipment which does not require any installation operations. They are delivered with a kit comprising:

- Battery charger
- Radio modem for the User Interface
- Removable wings for the glider configuration

In addition, an acoustic modem can be provided on demand, enabling the vehicle to exchange data also when underwater. This is a basic option for an AUV required to act in a team of networked robots executing cooperative missions such as environmental adaptive sampling or patrolling activities within harbours. It is also very useful for monitoring the AUV status during a long diving phase.

Finally, a very light remote control box with radio link can also be provided on demand. It enables to easily drive the vehicle in an intuitive way when on surface (without the need of a laptop) and furthermore makes vehicle recovery operations easier.

Software

Both eFOLAGA and eFOLAGA+ can be maneuvered using the same User Interface (provided with the robot), running on any Windows laptop and providing a wide range of commands for setting missions and configuring vehicle functionalities.

The user can develop his own software application and make it run onboard the vehicle: in their standard configuration, both eFOLAGA and eFOLAGA+ can be driven just through the User Interface, which allows to send commands to the vehicle low-level control loops and to define missions via composition of a set of predefined basic tasks such as "vertical dive", "rotation", "underwater navigation", "glider navigation", etc.

Although the existing tasks make a wide range of operations possible, advanced researchers may be interested in defining their own tasks, for implementing different control and navigation algorithms or for realizing applications based on additional payload equipments.

For this purpose, an optional software module, "User Control", has been developed providing a set of software primitives for driving the vehicle actuators and getting the feedback data from all the onboard sensors. The user can create an interface with the User Control and develop his own code, having access to all the vehicle sensors and actuators at a rate of 200Hz.

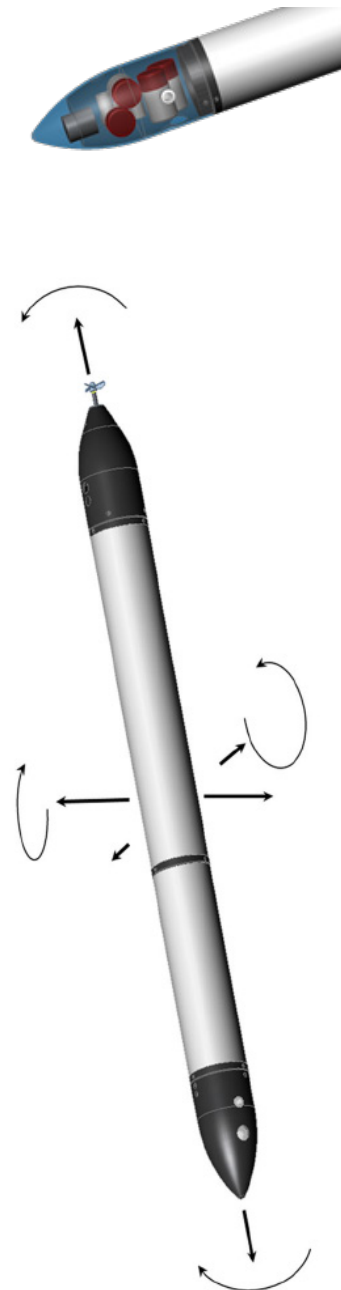

GÜDEL AG

GÜDEL

Description of the company

GÜDEL has been known as a supplier of automation, linear and drive technology for more than 50 years. Worldwide, GÜDEL has 700 employees, the headquarters are in Switzerland.

Industrie Nord
4900 Langenthal
Switzerland
<http://www.gudel.com>
+41 62 916 91 91
info@ch.gudel.com

Range of products

Modules: Linear one- and multi-axis portals

The linear one- and multi-axis modules are based on the standard components of the GÜDEL-guideway system. They are dedicated for payloads from 10 to 3600 kg.

MLB

Modular linear axis MLB with belt drives are especially suited for general handling applications for packaging and logistics, as well as for the food and medical industry.

EP

By virtue of its high modularity and its wide range of payloads the 1-axis module type EP lends itself to applications in diverse industries.

ZP

2-Axis Portals gantries type ZP with rack and pinion drive are used for applications in extremely diverse industries such as logistics, mechanical engineering, aerospace, medical technology, automotive etc.

FP

3-Axis Portals gantries type FP with rack and pinion drive are used for applications in extremely diverse industries such as logistics, mechanical engineering, aerospace, medical technology, automotive etc.

CP

3-Axis Cantilever portals type CP with rack and pinion drive are used for applications in extremely diverse industries in process-oriented applications.

TM / TMO

Modular linear axes Trackmotion Type TM with rack and pinion drive are used in diverse applications such as welding machines, plasma-arc cutting, mechanical processing, pouring, packing etc.



RoboFlex: 5-Axis Overhead Robot on a Linear Travelling Axis

The overhead robot roboFlex manufactured by GÜDEL is an innovative robot concept. It consists of a 5-axis robot arm which is fitted in a suspended position on a linear travelling axis. Thanks to the overhead robot roboFlex it is nowadays possible to position workpiece grippers and operating heads in any axes direction and angle required. The small mass guarantees very high dynamics and maximum rigidity and accuracy.



IBEROBOTICS, S.L.

IBEROBOTICS

Description of the company

IBEROBOTICS is a Spanish engineering company specialized in home and service robotics. It designs, manufactures, imports and sells home and professional service robots, made by IBEROBOTICS or by third companies. It also designs or personalizes special robotic solutions to cover the demand of the customers. IBEROBOTICS offers a wide range of brands and models of robots, it also offers custom developed projects and components and systems for robotics.

Consuelo Bergés, 14C, 2º Izq
39012 Santander
Spain
<http://www.iberobotics.com>
+34 902 875 791
info@iberobotics.com

Range of products

Robotic Vacuum Cleaners, Lawnmowers and Poolcleaners

IBEROBOTICS offers a wide range of home robots for domestic work: vacuum cleaners such as iRobot Roomba or Samsung Navibot (with integrated artificial vision) floor-washer e.g. iRobot Scooba, lawnmowers e.g. Zucchetti Ambrogio or Friendly Robotics Robomow and poolcleaners e.g. Dolphin from Astralpool or Cybernaut, Indigo and others from Zodiac.



Lego Mindstorms NXT v2.0

Mindstorms NXT is a popular educational product from Lego that offers a very fast approximation to the first skills of robotics with a graphical programming and a non-soldering construction. This platform offers a wide variety of possibilities with a flexible construction system in order to enable multiple projects in the classroom without knowledge of any programming language.

The basic educational platform can be expanded with I2C electronics systems, sensors and actuators to cover most educational and basic research projects. Examples of these accessories are pressure sensors, communications systems, artificial vision systems and others.



AMT50 and GNOM family of ROVs

Complete ROV systems for the laboratory pool or the open sea can be used to develop algorithms of underwater navigation, underwater communications, ROVs collaboration or test maritime sensors. The basic platforms can be completed with robot arms and manipulators, sonars, control systems, communication equipments, HD cameras, sensors and positioning systems. The equipment can be used for depths from 50 to 500 meters.



iVision

iVision is a professional service robot for the inspection of ducts and difficult access areas. It is controlled through a PC, with cable connection. The basic platform can be completed with robot arms, communication equipments, cameras and sensors.



Qbo

Qbo is a totally open source robot based in a mini-ITX PC with Linux. It offers a multipurpose platform with stereoscopic artificial vision, voice recognition, speech synthesis, auto charge station and indoor navigation. Qbo is a platform for the development and evaluation of programs of social skills, high-level social relationships, indoor artificial vision based navigation, visual pattern recognition, video surveillance or dependent people care systems. The open source based hardware and software permits the installation of the necessary hardware or software to complete your research project.



Airplanes, airframes and UAV platforms

Aircraft models and low-cost UAV platforms can be used as low-cost airframes or drones for the development and test of mission control systems, swarm systems, aerial photography and UAV flight systems. The airframes can be completed with electric or gas motors, high quality servos, flight control systems, communication equipments, HD cameras, sensors, GPS, IMU, AHRS and autopilot systems. IBEROBOTICS has many models and systems available: from gliders to basic UAV platforms and 3m wingspan airplanes, in order to cover the different requirements of each customer concerning velocity, autonomy and payload.



Helicopters, Quadcopters and Multicopters

Helicopters, quadcopters, tricopters, hexacopters and octocopters can be used as low-cost airframes or drones for the development of mission control systems, swarm systems, aerial photography and UAV flight systems. The helicopter and multicopter frames can be completed with electric (or gas motors only for helicopters), high quality servos, flight control systems, communication equipments, HD cameras, sensors, GPS, IMU, AHRS and autopilot systems. IBEROBOTICS has many models and systems available to cover the different requirements of each customer concerning velocity, autonomy and payload.



Bipeds, Hexapods, Quadropods and Multipods

Bipeds, Hexapods and other multi-legged platforms can be used to develop and test complex algorithms of displacement, navigation and movement patterns and for new applications that require special movement patterns such as inspection robots for difficult environments, climbing trees, lampposts or structures. The basic multi-legged frames can be completed with high quality servos, control systems, communication equipments, HD cameras, sensors and GPS systems.

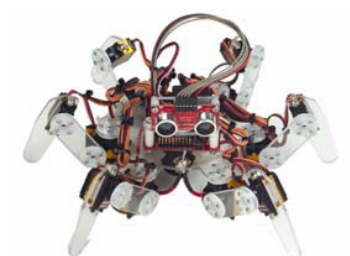

Wheeled and Tracked Platforms

Wheeled and tracked platforms can be used to cover the displacement requirements of any type of ground mobile robot (not legged) from the laboratory to all-terrain environments and to develop and test complex algorithms of displacement, navigation and movement patterns. Our catalogue covers the entire range from amateur-type low-cost basic platforms to high quality military-type platforms. The basic wheeled and tracked platforms can be completed with high quality motors and servos, robot arms, control systems, communication equipments, HD cameras, sensors and GPS systems.

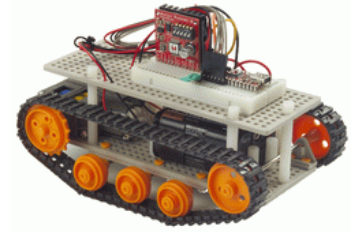

Boats

Racing boats (faster), sailing yachts (low consumption), natural model boats (payload) and custom designed boats. IBEROBOTICS offer a wide catalogue to cover the requirements of any type of Unmanned Maritime Vehicle from the laboratory pool to open sea and to develop algorithms of navigation or test maritime sensors. The basic platforms can be completed with high quality motors and servos, robot arms, control systems, communication equipments, HD cameras, sensors and GPS systems.



Robot parts, Components and Systems

IBEROBOTICS has many robot parts available to complete robotic platforms: motors, servos, lights, sensors, wheels, tracks, batteries, inertial measurement units (IMU), attitude and heading reference systems (AHRS), complete autopilot systems, GPS, communication modules, cameras and control boards. Special customized projects are also offered.



INGENIA-CAT, S.L.



Description of the company

INGENIA is a company which is specialized in designing, engineering and developing products for electric motion control.

It provides feature-rich motion control solutions that include state-of-the-art, compact, high power-density and network-based digital servo drives.

It has also extensive experience in designing affordable custom products optimized for an OEM's specific needs. Servo drive controllers can be adapted for specific applications in a few weeks (custom power, custom size, custom geometry, custom interfaces, etc.). INGENIA is constantly developing and improving its motion control technology and updating its product range to enable its customers to develop more complex and challenging motion control applications.

C/ Marie Curie s/n
Parc Tecnològic BCNord - A200
08042 Barcelona
Spain
<http://www.ingenia-cat.com>
+34 932 917 682
info@ingenia-cat.com

Range of products

Mercury

Mercury is a digital closed-loop servo drive for DC brushed and brushless motors, capable of driving motors up to a 1.1KW peak. Its design includes multiple communication ports, giving designers a wide choice of interfacing methods. Its extended voltage operation range allows it to be used in industry or robotics, and its reduced size allows the controller to be integrated into critical-size applications. The design also includes a wide variety of self-protection mechanisms (thermal, overcurrent, under and over-voltage, etc.). Other main features are the free firmware updates and the inclusion of a motion control API for C/C++, with functions that permit easy controller operation.

The main features are:

- Fully digital servo drive controller.
- Compact design.
- Sinusoidal and trapezoidal commutation (brushless motors).
- Space vector modulation (AC brushless motors).
- PWM modulation (DC brushed and brushless motors).
- Motion modes: Position, Velocity and Homing.
- Several feedback combinations.
- Programmable protections against overcurrent, under and overvoltage and overtemperature.
- Programmable general purpose inputs and outputs.
- On board temperature and bus voltage sensor.
- On-system upgradeable firmware.
- Easily programmed via API Motion Control Library in C/C++.



Round Mercury

Round Mercury is a high performance closed loop motor controller and driver for DC brushed and brushless motors, capable to drive motors up to 400W peak (200W continuous). Its design includes multiple communication ports, enabling thus a wide choice of interfacing methods. Its voltage operating range allows its use in industry or robotics applications, and the compact design allows the controller to be a valid OEM for critical-size applications. The design also includes a wide variety of self-protection mechanisms (thermal, over-current, under and over-voltage, etc.). Other main features are the free user-programmable firmware updates and the inclusion of a motion control API for C/C++.

The main features are:

- Fully digital servo drive controller.
- Compact design.
- Sinusoidal and trapezoidal commutation (brushless motors).
- Space vector modulation (AC brushless motors).
- PWM modulation (DC brushed and brushless motors).
- Motion modes: Position, Velocity and Homing.
- Several feedback combinations.
- Programmable protections against overcurrent, under and overvoltage and overtemperature.
- Programmable general purpose inputs and outputs.
- On board temperature and bus voltage sensor.
- On-system upgradeable firmware.
- Easily programmed via API Motion Control Library in C/C++.



Venus

Venus is a high performance, powerful compact servo drive controller for DC brushed and brushless motors (linear and rotary), capable to drive motors up to 2KW peak (1KW continuous). This advanced, high power density servo drive provides good performance, advanced networking and built-in safety, as well as a fully featured motion controller. Its voltage operating range allows its use in industry, medical, testing or advanced robotics applications. Other main features are the free user-programmable firmware updates and the inclusion of a motion control API for C/C++.

The main features are:

- Fully digital servo drive controller.
- Compact design.
- High power density.
- Multiple motion modes: Position, Velocity, Torque, Interpolated Position and Homing.
- Several feedback combinations.
- Motion controller capabilities.
- Programmable general purpose inputs and outputs (TTL and PLC levels).
- Brake and Shunt
- On-system upgradeable firmware.



- Easily programmed via API Motion Control Library in C/C++.
- Software tools (GUI) for quick system set-up and operation.

Custom motor servo drives

In many robotics applications a custom servo drive is the only way to reach high levels of efficiency (cost, energy and environment), performance and reliability. INGENIA offers custom solutions with fast time to market and latest motion control technology. It has extensive experience in designing affordable custom products optimized for robotics OEM's specific needs. Servo drive controllers can be adapted for specific applications in a few weeks.

Custom servo drive power

A digital servo drive controller with the electronics power needed by your application can be developed. The power may range from a few watts to several kilowatts.

Custom servo drive mechanical specifications

The desired size, connectors, layout and geometry can be chosen. The adapted servo drive controller that mechanically fits into a specific application can be developed by using advanced PCB and electronics design technologies. The mechanical integration of the developed servo drive controller is facilitated by providing 2D/3D model (*.step, *.dwg, *.dxf, *.iges, etc.).

Custom servo drive interfaces

The communication interfaces enable the communication with the servo drive. Some examples are: RS232, RS485, CAN, Ethernet, SPI, I2C, etc.

And more...

- Specific sensorless vector control algorithms
- Specific motion control modes
- Prototype validation complying with industrial standards (UL, CE, MIL spec)
- Series production (industrialization and manufacturing)

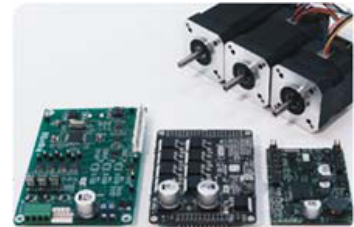

KUKA Roboter GmbH

KUKA

Description of the company

KUKA Roboter GmbH, with its headquarters in Augsburg, is a KUKA Aktiengesellschaft company and ranks among the world's leading suppliers of industrial robots. Core competencies are the development, production and sale of industrial robots, controllers, software and linear units. The company is market leader in Germany and Europe, and number three in the world. The KUKA Robot Group employs approximately 2000 people worldwide. Of these, almost 1100 are employed in Germany. In 2009, sales totalled € 330.5 million. With 25 subsidiaries KUKA is present in the major markets of Europe, America and Asia.

Zugspitzstr. 140
D-86165 Augsburg
Germany
<http://www.kuka-robotics.com>
+49 821 797-4000
helmutfiege@kuka-roboter.de

Range of products

KUKA KR5 arc HW, KR16, KR30 HA, KR180, KR360, ...

KUKA offers a wide range of industrial robots and robot systems, covering the common payload categories (from low (5 kg) to heavy duty (over 1000 kg)) and robot types. This enables a wide range of applications such as component testing, assembly of small parts, grinding, polishing and bonding, handling tasks, spot welding, handling and loading/unloading tasks, foundry tasks, etc.

Complex setups with several components:

Controllers

Thanks to a modular hardware structure and open, PC-based software architecture, the controller can be tailored to the specific requirements of the system. Furthermore, a wide range of expansion options are also available, which makes it easy to adapt your controller to changing production requirements or entirely new production tasks. This helps you to stay flexible – and your production to stay competitive.

Software

KUKA offers a large range of software products. KUKA robots have a wide variety of potential uses. To be able to fully exploit them, KUKA also offers advanced software tools (application, planning, simulation, controller, communication, control & observe, real time, conveyer, security updates and remote control).

Linear units KL1500, KL 250, ...

Linear units allow the robot to move along a horizontal axis, thereby extending the robot's work envelope.



Rotary units DKP400, KPF1V500V1, ...

KUKA provides also rotary units such as the turn- / tilt-table DKP400, and the turn-table KPF1-V500V1.

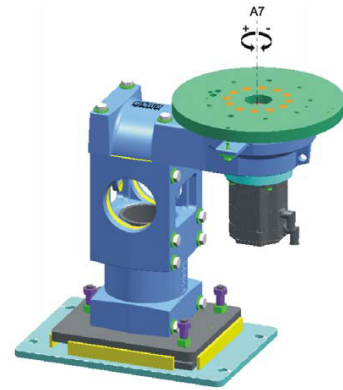

KUKA Lightweight Robot (LWR)

The KUKA lightweight robot is the result of a close cooperation between industry and researchers. Thanks to its sensitive sensors it is capable of yielding to humans and it “learns” by letting itself be guided. As a leading-edge technology, it is now set to assist university research in new fields of application for robotics. With its in-built sensitivity, achieved by means of the integrated sensors, the LWR 4+ is well suited for handling and assembly tasks. Due to its low weight of 16 kg, the robot is energy-efficient and portable and can thus be used for a wide range of different tasks. It can for example operate on a mobile platform. As a team, these two systems constitute the production assistant of the future – an autonomously navigating robot.



Kineo CAM



Description of the company

Kineo Computer Aided Motion "Kineo CAM" is the independent software developer of the worldwide leading technology for Automatic Motion and Path Planning, KineoWorks. Being focused on the development of off-the-shelf software, Kineo CAM collaborates with large companies and institutions including RENAULT, FORD, BMW, FIAT, PSA (PEUGEOT CITROEN), AUDI, AIRBUS, UGS TECNOMATIX, CEA, EDF, AIST Japan, Optivus Technology Inc. etc.

Incorporated in December 2000, Kineo CAM benefited from a 15-year research legacy from the Laboratory for Analysis and Architecture System "LAAS-CNRS". Kineo CAM builds close relationships with Research Labs in Europe, Americas and Asia.

**Rue de la Découverte
Miniparc BP 57748
31677 LABEGE CEDEX
France
[http://www.kineocam.com/
kitelab](http://www.kineocam.com/kitelab)
+33 (0)5 61 00 90 60
contact@kineocam.com**

Range of products

Kite Lab™

Kite Lab™ is a software development platform created by Kineo CAM as a sideline of its industrial and commercial software development platform called Kite™. It is primarily dedicated to academic and non profit organizations and strictly intended for non commercial use.

It is a software development platform dedicated to 3D applications and 3D robotics to develop research work through standard Application Programming Interfaces (API). It covers a large range of uses like robot arms, medical robots or highly articulated systems. It provides the core software architecture needed to build a 3D application dealing with static and dynamic collision detection, kinematics, motions, etc.

The main features are:

- Adding physical properties to motion
- Connecting external devices such as haptics or 3D recognition
- Creating dedicated Robot simulators
- Implementing task planning and scheduling
- Integrating additional constraints in simulation
- Specifying trajectory optimizations
- Writing CAD importers
- Generating Mannequin ergonomic postures
- Embedding GUI-less engine in systems
- 3D engine
- Graphical kinematics editor
- Static and dynamic clash detection
- Automated collision-free path computation
- Obstacle penetration control
- Path optimization
- zoom, pan, rotate, multi views,...
- 3D simulation and movie generation
- Post treatments thanks to XML format

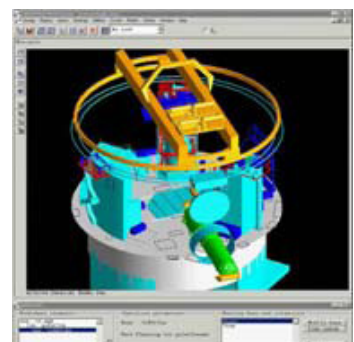
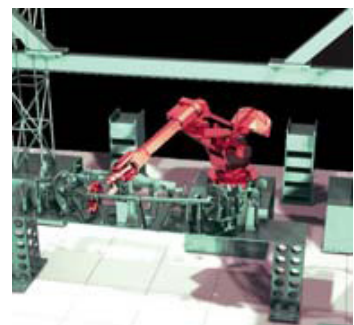

Locomotec UG



KUKA

Description of the company

Locomotec UG (with limited liability) was founded in March 2010 with the business objective to develop and commercialize locomotion technology in general and intelligent systems for mobility support and assistance. A first prototype of a device for supporting and exercising individual mobility has been developed and is currently being patented. In summer 2010, Locomotec started a joint venture with KUKA Roboter and the new KUKA Laboratories for affordable robot platforms for education and research and robotics application development as a second business branch. Locomotec is a KUKA system partner and the exclusive distributor of the educational mobile manipulator KUKA youBot.

Locomotec operates the KUKA youBot Store, which is not only an online shop for KUKA youBot hardware, but also intends to become a leading market place for open source software and educational material for mobile manipulation. Locomotec is currently converted into a GmbH.

Manufacturer:
KUKA Laboratories GmbH
Zugspitzstr. 144
86165 Augsburg
Germany
Vendor:
Locomotec UG
Am Hasenberg 3
86899 Landsberg
Germany
<http://youbot-store.com>
+49 711 656 936 0
info@locomotec.com

Range of products

KUKA youBot

The KUKA youBot is a mobile manipulator that was primarily developed for education and research. The KUKA youBot comes with open interfaces and allows the developers to access the system's various levels of hardware control. It further comes with an application programming interface (KUKA youBot API), with interfaces and wrappers for recent robotic frameworks such as ROS, with an open source simulation in Gazebo and with some example code that demonstrates how to program the KUKA youBot. The platform and the available software enable the user to rapidly develop his/her own mobile manipulation applications.

The KUKA youBot consists of two main parts, which can be purchased and used independently from each other or together as an integrated system (with single or dual arm). Additional sensors can be mounted on the robot.

KUKA youBot omni-directional mobile platform

The omni-directional mobile platform consists of the robot chassis, four mecanum wheels, motors, power and an onboard PC board. Users can either run programs on this board, or control it from a remote computer. The platform comes with a Live-USB stick with preinstalled Ubuntu Linux and drivers for the hardware.

KUKA youBot arm

The KUKA youBot arm has five degrees of freedoms (DOF) and a two-finger gripper. When connected to the mobile platform, the arm can be controlled by the onboard PC. Alternatively, the arm can be controlled without the mobile platform by using an own PC connected via Ethernet cable.



m-BOT solutions SL



Description of the company

m-BOT Solutions SL is a technology-based company focused on service robot applications. The company was established as spin-off from the Intelligent Robotics and Computer Vision Group (IRCV) from Rovira i Virgili University (Tarragona – Spain). Since 2006, m-BOT Solutions SL has managed projects in the field of mobile robots and technological products development and custom R&D for universities and private companies. m-BOT Solutions products comprise indoor robotic platforms using autonomous navigation and outdoor robots for exploration practices or intelligent vision systems. The company offers a comprehensive solution to satisfy customer needs concerning design, manufacturing, programming and commercialization, by integrating market components or technological components developed in-house.

**Av. Països Catalans, 26
43007 – Tarragona
Spain
<http://www.mbotsolutions.com>
com
+34 977 256 578
<http://info@mbotsolutions.com>**

Range of products

ROINBOT®

ROINBOT® is a social robot developed by m-BOT Solutions to work at congresses, in museums, at shows and any event or show with public assistance. ROINBOT® has been designed to give or receive information from the users and to help them. It moves safely and autonomously around the event looking for people to show them videos or presentations with the integrated touch-screen display, play music or give spoken programmed advice or speak sentences. Its capabilities, hardware system and wireless net make ROINBOT® easy to integrate, operate and communicate in any kind of environment.



SBV1, SBV2, SBV3

The robotic platform family SBV# is a 4-wheel based robot, developed mainly for teaching, universities and research groups whose applications are carried out mostly outdoor. It has been designed for all terrains and version 2 is also suitable for aquatic environments. Navigation via GPS and artificial vision systems can be supported by this platform which makes it suitable for exploration applications.



m-BOT SOLUTIONS S.L. m-BOT Solutions S.L.
Av. Països Catalans, 26
43007 – Tarragona-SPAIN info@mbotsolutions.com **SBV2** FIELD ROBOT PLATFORM

M-Tecks EAC Sarl



Description of the company

The mechanical engineering company M-Tecks EAC applies its skills and resources to the fields of research, development and design, especially for innovative solutions in mobile robotics and high ground-clearance vehicles.

Thanks to its experience in the mechanical industry (numerical simulation, design and realization of production tools for the mechanical industry) and in project management, M-Tecks EAC can customize the ARTHRON product line for user specific requirements. The robots in the ARTHRON product line (mechanic and electronic parts, software) are designed and produced by M-Tecks EAC.

Les Levades
ZA de la Galive
19600 SAINT PANTALEON DE
LARCHE
France
<http://www.M-TecksEAC.com>
<http://www.arthron.com>
+33 05 55 24 22 86
f.marsaleix@M-TecksEAC.com
contact@M-TecksEAC.com

Range of products

ARTHRON R

M-Tecks EAC offers a wheeled-robot range with an articulated structure that enables a high-crossing capacity. These robots are available with a varying number of modules (2 to 5) in order to increase the crossing and progressing capacity without changing the robot height. The 130 mm high ARTHRON robots are able to climb obstacles ranging from 150 mm (3 modules version) to 500 mm (5 modules version). Robots are available in wired and wireless versions (400 m range in an urban environment for the wireless version).

ARTHON R075, ARTHRON R100

These robots are designed for applications such as pipe inspection, civil security, building surveillance or defense. They can be integrated into a more global surveillance system with other robots (possible communication between them to surround an area) and other means of monitoring. These robots can be used to confirm the absence of danger in case of alert or to set up automatic surveillance.

ARTHON P

M-Tecks EAC has designed a robot able to walk up ferromagnetic walls and high angle slopes. While maintaining the articulated structure of the wheeled ARTHRON the wheels are replaced by a set of legs. This robot is destined for use on metallic structured buildings (such as bridges) and industry inspection (such as tanks, ships...).

ASCA

ARTHRON robots are supplied with remote control software. This software is adapted to the robot's mechanical structure in order to give the user the description of its state and control assistance. For research purposes, M-Tecks EAC delivers the ARTHRON robotic platform with embedded computer and environmental sensors: such as laser scanners, numeric video, GPS.... thus forming an open research platform for independent behavior in natural environment or rough ground.

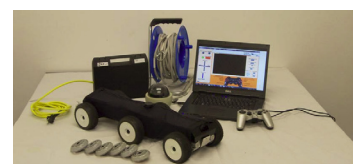
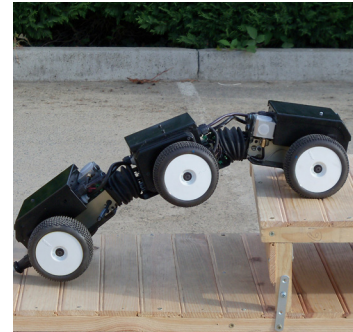

Magellium



Description of the company

Magellium is a French company specialized in imagery. The company has been created in 2003 and it currently employs 130 people, more than 50% of them are specialists in image processing and computer science. Magellium provides solutions in the fields of space and defense imagery, robotics, GIS & cartography and more recently healthcare. The Robotics Department of Magellium leads projects in autonomous mobile robotics, especially for planetary exploration (ESA, CSA, CNES). Its activities cover a wide range of topics, from stereovision system engineering and calibration to 3D localization and environment mapping, passing by rover control and UGV/UAV cooperation.

**24, rue Hermès - BP 12113
31521 Ramonville Saint-Agne
cedex
France
<http://www.magellium.com>
+33 562 247 000
olivier.lefebvre@magellium.fr**

Range of products

MAGEYES

MAGEYES is a high precision stereovision sensor. It is delivered pre-calibrated using a patented technology developed at CNES (French Space Agency) and involving a light collimator. It meets the ExoMars ESA mission precision criterion and the typical accuracy is as follows (for one stereo image pair):

- bottom of the image (about 1m distance): 6mm
- middle (about 3m distance): 10mm
- top (about 5m distance): 22mm

MAGEYES can easily be controlled using MAGPER.

MAGPER

MAGPER is a visual perception software application that performs the 3D reconstruction process from stereo images: image acquisition, correction and rectification, stereo-correlation, 3D reconstruction. It is delivered as a GUI application and as a library with C++ API for integration into the users' own applications. It includes a flexible 3D viewer.

MAGVME

MAGVME is a visual motion estimation (VME) software application. It takes sequences of stereo images as inputs, and other sensors if available (INS, compass, etc.) and computes in real-time the motion of the system. It meets the ExoMars ESA mission precision criterion: relative error on travelled distance is less than 5%. It is delivered as a library with C++ API.

MAGNAV

MAGNAV is an autonomous navigation software application. It is designed for outdoor rover navigation and computes the following: Digital Elevation Map, navigability map, collision-free path computation. It has been validated in planetary exploration mission scenarios. It is delivered as a modular library with C++ API.

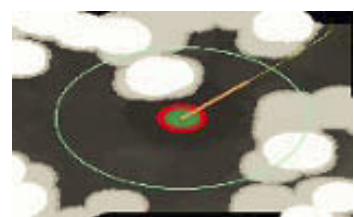
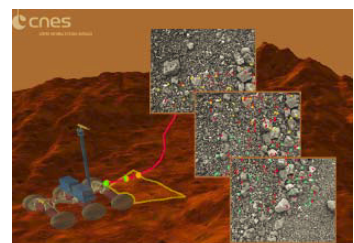
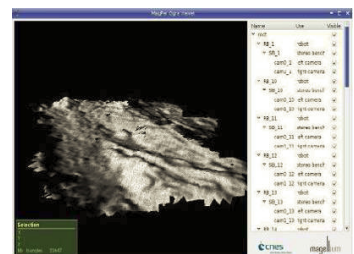

Merlin Systems Corp Ltd



Description of the company

Merlin Systems Corp is a UK based company operating on a global scale and consists of: Merlin Robotics, Merlin Innovations, Merlin Wireless and Merlin Proximity.

Merlin Systems Corp is an established manufacturer, developer, integrator and innovator of advanced robotics technology. Our mission is to build robots that are useful to people in "people environments". This is a long term goal, and one that requires new technology and new ways of thinking. Merlin is supporting this goal by developing researcher oriented tools and technology as well as providing comprehensive system integration services for academic and commercial partners.

Plymouth International Business Park
Buckland House
12 William Prance Road
Plymouth
PL6 5WR
United Kingdom
<http://www.merlinsystemscorp.co.uk>
+44 845 3888 450
sales@merlinsystemscorp.co.uk

Range of products

MiobotPRO Autonomous Robot

The MiobotPRO features high-performance motors and precision encoders. It can travel up to 3m a second and has an encoder resolution of 0.04mm. The onboard PID control algorithm provides fast, controlled motion. The MiobotPRO is a programmable robot (with development kit) with onboard Bluetooth communications allowing it to be fully controllable wirelessly, via simple ASCII serial protocol. (MiobotPRO API) The MiobotPRO API offers simple integration and ease-of-operation via a simple command line / serial protocol being used in: Lab View, C++, CH, VB etc. Applications of the MiobotPRO in use include: University research, FIRA Robot, Football, Robot Soccer and Co-operative Robotics.

MiobotPRO Research Kit

The MiobotPRO Research Pack contains all the accessories and software needed to research and evaluate the MiobotPRO Robot and includes the MiobotPRO API. This package will also allow the user to try out MiobotPRO before moving onto a 3, 5, 7 or 11-a-side Robot Football package. The MiobotPRO Research Pack includes: 1 x MiobotPRO (with Black anodised body) / 1 x Class 1 Bluetooth Dongle (100 metres) / 1 x Programming Kit supplied on CD Rom / 1 x Transit storage case / 1 x Interactive Control Joystick / 1 x Interactive control software / 1 x Fastcharge MiobotPRO Battery Charger.

MiobotPRO Gripper

The MiobotPRO Gripper comprises of: a mechanical attachment operated by pulse width-controlled servo motors / An additional PCB on top of the robot, with connectors linking the servo connections and power supply to the MiobotPRO expansion port / Extra control software to produce pulse width control outputs. The MiobotPRO Gripper mechanics fit to the front of the robot and have two degrees of freedom. The grips are equipped with foam pads to ensure a limited compliance.

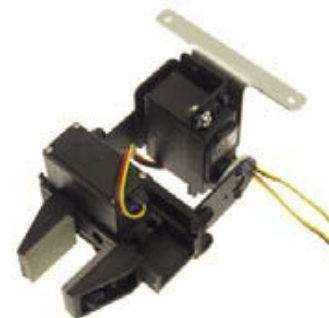

MiabotPRO 8-way Sonar Turret

The MiabotPRO 8-way Sonar Turret is an innovative new way in which a robot can be aware of its environment in all directions - without the need to 'sweep'. It interfaces eight sonar-ranging modules at equally-spaced angles to sense objects to the left, right, front and back. The 8-way Sonar Turret has a full 360 degrees coverage, allowing for a far more accurate view of its surroundings. In a research environment this gives small robots the sensing power of much larger mobile robot platforms. Firmware on the MiabotPRO allows distance information from all eight sensors to be sent back to a PC (via Bluetooth) with the returned data being easily integrated into an existing application.



MiabotPRO Starboard

The MiabotPRO Starboard provides a flexible active illumination system. It has been designed to be used in conjunction with the Merlin Overhead Tracking System (MOTS) but can be incorporated in any active overhead vision system. The onboard LED's can be configured via software to encode different ID's (up to 16 using Green LED's) and provides robot orientation fiducials (using Red LED's - so you know which way the robot is travelling). The MiabotPRO Starboard enables vision to be used in unstructured lighting conditions that would otherwise be impractical for standard passive vision systems.



MiabotPRO Line Following Kit

The MiabotPRO Infra-red line following kit is attached to the expansion port on the front of the MiabotPRO. The sensor kit delivers three digital signals to the micro-controller enabling the MiabotPRO to reliably follow a black line on a white background, or vice versa. This reliable, easily-set-up application will perform effectively time and time again. The kit has three reflective sensors made from one-piece infra-red LED and photo detector pairs that are directed at the surface in front of the MiabotPRO. Each of the sensors looks for reflected IR light. When one of these sensors is positioned over a dark or black surface its output will be low. When it is moved to a light or white surface it's output will be high. The micro-controller monitors these signals and moves the MiabotPRO according to the signals.

MiabotPRO Compass

The MiabotPRO Compass Module is specifically designed to aid navigation. The compass uses two magnetic field sensors (sensitive enough to detect the Earth's magnetic field) mounted at right angles to each other, to compute the direction of the horizontal component of the Earth's magnetic field.

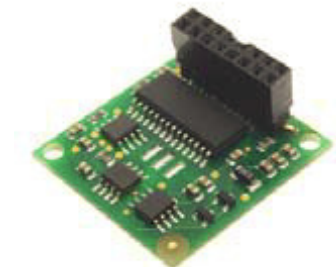

MiabotPRO Camera

The MiabotPRO Onboard Vision Processing Camera is a miniature colour video camera module and is ideal for mobile video applications such as remote monitoring or robot vision. In addition to basic video capture, the camera provides 'frame-rate colour region tracking' and is therefore ideally suited as a low-cost solution. Camera control and output are provided as either RS232-compatible serial signals or as an I2C-bus link. Alternatively, a miniature Bluetooth module can be fitted for remote wireless access.

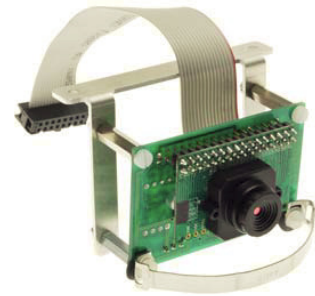

MiabotPRO MOTS

The MiabotPRO Overhead Tracking System (MOTS) allows numerous robots to be tracked in real-time in indoor environments over large areas. The system uses multiple cameras and local real-time vision recognition servers to cover the area being tracked. Each camera / local server is able to cover an area approximately 1.5m x 1.5m and transmit tracked robot information over a network to a global vision server, which receives feedback from all the available cameras to provide a final global coordinate transform.

Robot Football Systems

The MiabotPRO Robot Football System is recognised throughout the world as a leader in its field. Fully Mirobot FIRA Robot Soccer / Robot Football compliant and custom made to user requirements and budget, the system features the MiabotPRO Mirobot Robot. Typically offered as either a 3, 5, 7 or 11-a-side format the system can be used to demonstrate an autonomous 'robot soccer / robot football game' or be played interactively using joysticks to enthuse the audience or group of students. With a host of add-on extras and enough robots to illustrate different experiments, the system offers you a wide flexibility. The MiabotPRO Robot Football System is used in research, education, manufacturing, service industries and beyond.

Custom Robotics and Research Labs

Merlin Robotics continues to develop exciting products, projects and applications. In 1998, the 'Intelligent Servo Air Muscle' was developed. It incorporated ground breaking Merlin technologies and has continued to innovate and lead from the front. 'bespoke' robotic solutions are suggested from initial design to manufacture and implementation - a leading UK company exporting worldwide. Examples of which include The three following products:

Robot Snake

A 2m tall, upright autonomous dancing snake, created using Merlin Servo Air Muscle technology.

Robot Arena

Fully autonomous robots with multi-camera vision tracking.

Robot Machine Shop

Fully automated miniature robot factory floor.

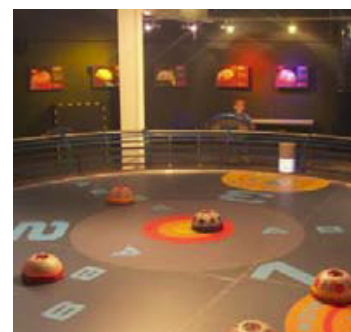

MetraLabs GmbH Neue Technologien und Systeme



Description of the company

MetraLabs produces high-performance mobile robot platforms and complete service robot applications for day-to-day usage. Its main fields are mobile monitoring, flexible intralogistics, mobile service guides and mobile robots for research. Its mission is to create robots that inspire. Approved industrial technologies, safety standards and cutting-edge robotics research are combined. Businesses are provided with an affordable highly advanced robotic platform that is able to make the work place safer and run more smoothly. Technology that was once only available in theory and in research is now available for the commercial sector. Any business can benefit from the advantages that automation has to offer, from becoming more efficient to more cost effective.

Ehrenbergstr. 11
98693 Ilmenau
Germany
<http://www.MetraLabs.com>
+49 36 77 66 74 31 11
andreas.bley@metralabs.com

Range of products

Mobile platform SCITOS A5

SCITOS A5 is a versatile mobile service-robot, which pleasantly communicates with people. Driving and approaching people autonomously, it certainly works well at the "Point-of-Sale", an exhibition booth or inside an office building. It neatly displays videos or presentations on the integrated touch-screen display along with the audio sound system. Comprehensible speech and music can be played back as well as synthesized, and, depending on the desired situation, it is able to sound serious to build confidence or it can be funny.

Due to the implemented Intel Core 2 Duo Mobile Technology, SCITOS A5 can be integrated, without any difficulties, into existing communication-networks for wireless data transfer.



Mobile platform SCITOS Tray Transporter

The SCITOS Tray Transporter is perfect for fast food restaurants and cafeterias. The Tray Transporter is able to detect when it is full of trays with dirty dishes and then fully autonomously brings these dishes into the kitchen in order to be cleaned. The advantage of this robot is that unpleasant and disturbing dirty dishes are no longer left in the dining area any longer than they need to be. Employees no longer have to constantly check how full the tray racks are and can then focus more on the preparation of food and serving customers. The Tray Transporter can be built to fit any situation and environment.

Due to the incorporated CogniDrive navigation software there are no environmental changes as well as external sensors or markers necessary. With a small built-in sensor the robot is able to operate kitchen doors and eliminate the need for employee help.



Complex setups with several components:

CogniDrive

The navigation software package CogniDrive enables the mobile robot SCITOS G5 as well as any other mobile robot system or autonomous guided vehicle to reliably drive in complex and fast-changing indoor environments to its desired location. It includes maps, a localization module, a path-planner and a collision avoidance system. CogniDrive has been driven thousands of kilometers in different industrial and retail situations. The path-planning module always calculates the optimal path to the destination, including the possibility to avoid narrow passages or high-traffic regions. If a moving object or a person is crossing the way of the robot, the CogniDrive software adjusts the current path in real-time and uses another way to reach its destination. The localization algorithms of the CogniDrive software are based on the sensor information of the vehicle. To create the robot's map, one has to teach the robot by driving the robot platform around manually the first time. It is not necessary to install markers or other guidance information into the robot's environment. The modularity of this navigation software allows the user to give further flexibility to the motion planning of the robot. The possibility to define no-go-areas, speed-limit-regions, or even traffic rules further increases its usability. Special cases, like the docking procedures, can be individually developed and integrated without influencing the stability of the whole CogniDrive software.

Mobile platform SCITOS G5 advanced edition

The advanced mobile robot platform SCITOS G5 combines the advantages of industrial robots, such as robustness and longevity, with the mobility and flexibility of research robots, which are necessary for the development of mobile and interactive robotic applications (payload: up to 50kg without curtailing the driving performances, top speed: 1,4m/s in translation and 200deg/s in rotation). Thanks to these performances, experiments in Research and Development projects in the area of robot applications can be carried out. Almost any indoor use is possible (classical autonomous navigation tasks, elaborate and analysis techniques for mapping, localization, path-planning, experimental studies associated with SLAM procedures, Human-Robot-Interaction, detection, tracking, adaptive conversational control, surveillance, inspection or monitoring, guide with pilot and information system functions in public building, help for handicapped persons ...). Based on this robot platform real world applications are already realized such as mobile shopping robots, mobile monitoring devices or autonomous tray transporter.



Complex setups with several components:

A high performance embedded PC technology provides a solid base for real-time approaches and image & audio processing. The SCITOS RoboHead can be used, e.g., for expressing basic emotions, pointing to specific positions around the robot, or showing changes of direction during driving. Furthermore, the integrated head lights, composed of 32 LEDs, can be used to give further feedback to the users. The table below gives an overview about available standard add-ons related to the typical fields of applications:

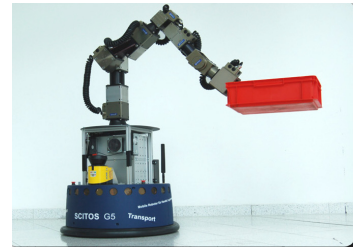

Application:
Autonomous Navigation

- Module:
- Security laser range finders
 - Front camera for visual obstacle detection
 - CogniDrive: Software package for autonomous navigation & obstacle avoidance

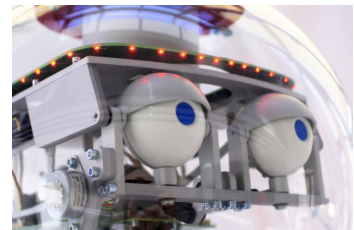

Human-Machine-Interaction

- High-resolution cameras & omni-directional cameras for people detection
- Touch-display interface with microphones & stereo speakers
- High quality omni-directional microphone for speech recognition

Mobile Manipulation

- Robot Head
- SCHUNK LWA, PowerCube modules & manipulators
- SCHUNK gripper

Every day usage

- Autonomous charging station
- I/O-ports for additional devices
- Closed enclosure



NAV ON TIME



Description of the company

NAV ON TIME is a young company specialized in satellite navigation with sub-meter accuracy. It develops and sells innovative GPS solutions for high precision control of mobile machines at competitive prices.

NAV ON TIME's know-how is to design navigation and guidance solutions for demanding applications in terms of precision, safety and confidence. Our solutions improve the mission effectiveness of mobile machines, from farming machines to service robots, by delivering the right level of services from basic guidance and operator assistance to fully automatic machine control.

NAV ON TIME's technologies are suitable for all situations which require a precise location and / or a steering system which is more or less automated.

Its strengths are GNSS (Global Satellite Navigation Systems), sensor fusion, navigation and guidance, embedded systems, use of geographical information systems, communication by datalink.

**42 avenue du Général de
Crouette
31100 Toulouse
France
<http://www.navontime.com>
+33 5 61 40 30 57
info@navontime.com**

Range of products

OCTANT

It is a high precision (2 cm) and low cost single frequency GPS RTK (Real Time Kinematics) positioning system. With its "10-Cubed" proprietary firmware, the accuracy of a standard single frequency L1 GPS by 1000 is improved. "10-Cubed" includes multiple levels of integrity monitoring and is particularly resistant to multipath environments. The OCTANT system consists of a kit including station and rover, bringing together RTK high precision positioning:

- the station, easily set up in the service area, simply receives the GPS L1 data and transmits them through its UHF data link,
- the rover integrating the "10-cubed" firmware can be easily embedded on board of any platform or vehicle (robot, tractor, crane,...)

OCTANT is the affordable basis for high precision applications (geo-fence, guidance, anti-collision) in many fields (agriculture, robotics, construction, mapping, handling). It can interface with various types of equipment compliant with NMEA standards.



MOW BY SAT

MOW-BY-SAT is a control system for automatic lawnmowers guided by satellites. It is a GPS guiding system for autonomous lawn mowers. It allows to do without the currently buried wire. It combines highly reliable and accurate RTK positioning with an integrated automatic steering system allowing the user to define all the parameters for lawn mowing (limits of specific zones, obstacles, smart guidance, return to the charging station...). MOW-BY-SAT is:

- a hardware solution for high precision (RTK) positioning: fixed base + embedded system
- a software solution for steering by satellite, and customized to the automatic mower
- a remote Human Machine Interface solution for planning and controlling the activity by the user: SuperVeeze

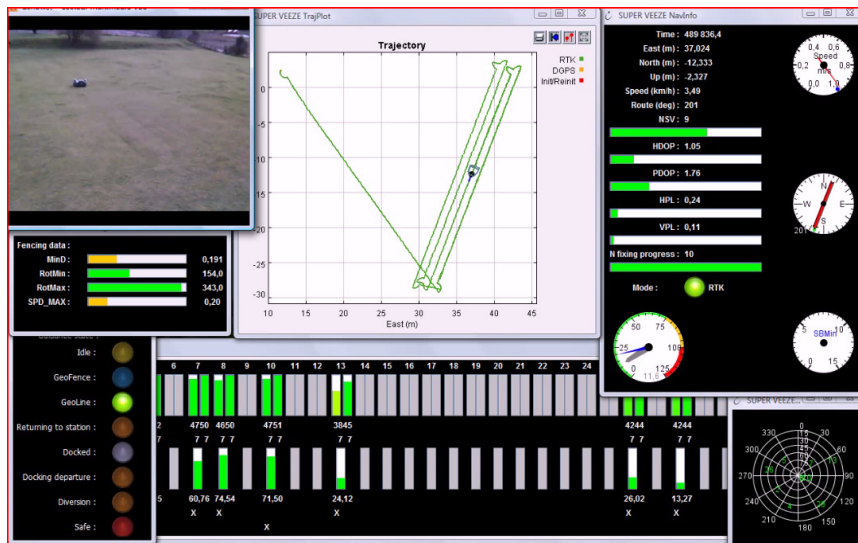

Neobotix GmbH

NEOBOTIX

Description of the company

Neobotix develops and builds mobile robots for both research and industrial use. Since the first installation of three entertainment robots in Berlin in 2000, our products have been improved and innovative solutions developed. Our mobile platforms are used in several research projects all over Europe, for such different fields as autonomous navigation, human-machine-interaction, object recognition and handling or autonomous measurement in different environments.

Industrial applications for which Neobotix robots are used include dynamic part handling, intra-logistics and laboratory automation. Based on years of experience and close contacts to many companies with expertise in related fields, innovative solutions are provided in other areas of industrial automation as well.

Innovationsfabrik Heilbronn
Weipertstr. 8-10
D-74076 Heilbronn
Germany
<http://www.neobotix.de>
+49 7131 -7669-300
may@neobotix.de

Range of products

MP-S500, MP-M470, MP-L655, MP-XL800, MPO-500, MPO-700

All Neobotix hardware products are based on our line of mobile platforms. These six basic models cover the payload range from 50kg to 500kg with corresponding speed and agility.

While less than knee-high, the MP-S500 can carry up to 100kg and move fast and swiftly even through narrow passages and on rough industrial floor.

The payload of the other platforms increases with their size. The biggest robot, the MP-XL800, is capable of carrying up to 500kg of cargo while providing internal space for additional components. All platforms use safety approved 2D laser scanners for localization, navigation and obstacle avoidance. Mapping and defining target stations and interconnecting paths are easily done via an intuitive graphical user interface. The well-proven motion control software PlatformCtrl does not only handle all basic driving features but also contains modules for localization, dynamic path-planning, obstacle avoidance and input/output handling.

Due to the generic approach of the basic platforms and control software they can be used in many different applications, such as simple transport and material transfer, for entertainment, for carrying sensor arrays and, of course, for any kind of robotics related research.

All mobile platforms can easily be integrated into complex systems, since they come with a wide range of different interfaces. Digital and analogue inputs and outputs can be used to connect buttons, switches, indicators, simple actuators and even safety devices. The wireless Ethernet connection of the platforms allows them to be controlled via the GUI from anywhere in the local network. For advanced control and interaction customized control software can use the open Neobotix communication protocol or communicate via Modbus. A powerful client to convert customer's Python scripts to Neobotix commands is also available.



MM-500, MM-655, MM-KR16

Neobotix also offers sophisticated mobile manipulators based on the standard platforms. With their integrated robot arms these systems are able to handle parts and material fully autonomously. They can perform pick and place tasks, take different parts to and from a storage area, feed machines or handle scanners and sensors. The combination of mobile platforms and manipulator arms finally allows full automation of tasks that were much too complex until now.

Neobotix' arm control software ArmCtrl can coordinate up to ten axes at the same time in PTP motion. Different kinematics are provided in the package so that arms with up to six axes can be moved in Cartesian and linear motion mode while the remaining axes are used in grippers or other auxiliary actuators.

Communication between ArmCtrl and higher-level controllers is as easy as interacting with PlatformCtrl. A graphical user interface is available for tests and first steps but also for teaching poses and motions. Neobotix' Python interpreter allows the user to create convenient and easy to maintain programs in Python without the need to implement the complete protocol. Thus even complex tasks can be realized with little effort and in less time.

To reach highest efficiency a mobile manipulator has to closely interact not only with its physical surrounding, but also with different machines and control systems. All the interfaces that are already available in the mobile platforms can be used to coordinate the robot's actions with the other devices required for the application. Digital and analogue IOs can be used for simple sensors and actuators, wireless Ethernet and several control options allow the customer to easily integrate the mobile manipulator into existing systems and applications.



Customized mobile platforms and manipulators

All standard products from Neobotix can be customized to meet the requirements of the research project they are used in. This may be simple things such as adding optional components, but can also include heavy modifications of the default system and the integration of several highly specialized devices for very complex applications.

Due to the open structure of the platforms and the modular design, most modifications can be realized in short time and very cost-efficiently. This results in more time and resources for the main project work while still having state-of-the-art hardware for experiments and tests.

Both PlatformCtrl and ArmCtrl provide important and well-proven basic functions for mobile robots. Integrating them into large experiments or projects is very easy and eliminates the need to spend time and manpower on features beside the project's focus. Interfaces to almost any middleware can be provided to further facilitate the integration process.



Customer specific robots for unique applications

In some cases, modifications of existing platforms are not enough and a completely new robot has to be designed and built from scratch to meet the special requirements of a complex research project.

Neobotix has gained experience in this very demanding field of engineering and successfully provided unique experimental robots for several big projects. These robots differ from mere modifications by being designed to match the demands and constraints of a given task. Especially when doing research on human-machine-interaction each project has its very own approach, use cases and interests. Neobotix provides robots with customized kinematics, size, processing power, sensor equipment and design.

The same modules and components as in all other Neobotix platform are used whenever possible, so that the software packages PlatformCtrl and ArmCtrl can be used with fully customized robots as well. Therefore, even highly specialized projects can benefit from all the advantages of off-the-shelf systems while still having maximum design flexibility.



OC Robotics



Description of the company

OC Robotics is a supplier of Snake-arm robot solutions. This includes the complete life cycle of a project, from feasibility studies through to the delivery of a product through to training, maintenance and support. OC Robotics is a world leader in defining, designing and delivery of snake-arm solutions for many industries such as nuclear, aerospace, defence, oil and gas and automotive. Specialties include the design, development and deployment of bespoke manipulators for complex problems and environments, consultancy and case studies for challenging projects, and support and maintenance for existing manipulators.

Unit 5
Abbey Wood Business Park
BS34 7JU
<http://www.ocrobotics.com>
com
0117 3144700
contactus@ocrobotics.com

Range of products

Snake-arm Robot

Snake-arm robots are wire driven self supporting manipulators for remote operations in hazardous and confined spaces. Operation is simple: the operator flies the tip and the body 'nose follows' the path created by the tip. OC Robotics' snake-arm systems comprise five main components; the control system including the operator interface, an introduction axis, an actuator pack, a snake-arm and a tool.

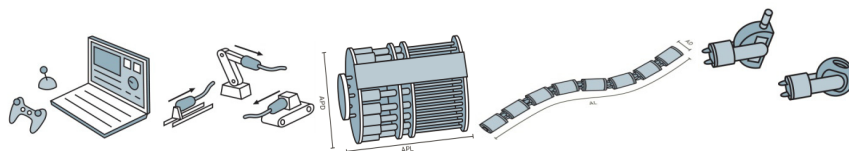

The tool is specific to the process task. OC Robotics has experience of integrating a range of tools including: cameras, grippers, sampling tools, water-jets, lasers and various heavier processing tools. Precise user requirements can be discussed in order to define an appropriate tool-set.

The snake-arm is actuated by the actuator pack. The actuator pack is attached to an introduction axis allowing the arm to nose follow into the environment. The control system contains all the electronics and computing equipment required to operate the system. The actuator pack, introduction axis and control system are typically located outside the confined or hazardous area. The arm itself contains no actuation or electronics making it ideal for harsh environments. They also have hollow bores allowing a number of services to be routed to the tip. This could include electronics or pneumatics for end effectors, cameras, grippers, sampling tools, a pipe for water jetting or vacuuming or a laser fibre for laser processing. The arm is lightweight, slender and easily sleeved. Only the detachable arm and tools have the potential to become contaminated.



Services

OC Robotics provides a comprehensive consultancy and analysis service. The first stage of this service is analysis through software simulation. OC Robotics' sophisticated Snake-Arm Simulator software allows a user to control a virtual arm through a virtual environment. The environment is constructed by experts at OC Robotics, and in close collaboration with the client. This is a powerful 1st stage in investigating how best to solve the problem. The second stage of this service draws on project experience of OC Robotics. The Engineers at OC Robotics have an abundance of experience in analysing their clients' industrial environments – whether that's the inside of feeder cabinet at a nuclear power station or the inside of a fuel tank or gas storage facility – and finding the right snake-arm for the job. As a third stage, OC Robotics can also supply mockups of environments. OC Robotics will provide a clear report on what the best solution is and how it will work. OC Robotics software simulates the arm with a high level of accuracy, but nothing can replace seeing a real snake-arm in action. OC Robotics clients often benefit from seeing a snake-arm moving through a mock up of their environment.

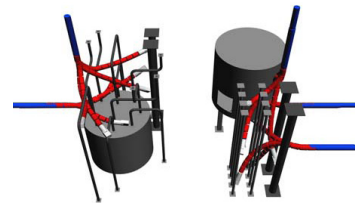
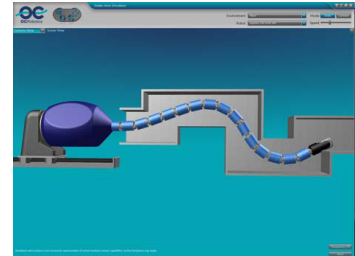

Explorer

OC Robotics Explorer snake-arm is available for research and development institutions. Custom tool mounts can be provided to allow institution to interface their own tooling and fully explore the potential of snake-arms for their unique environments and challenges.

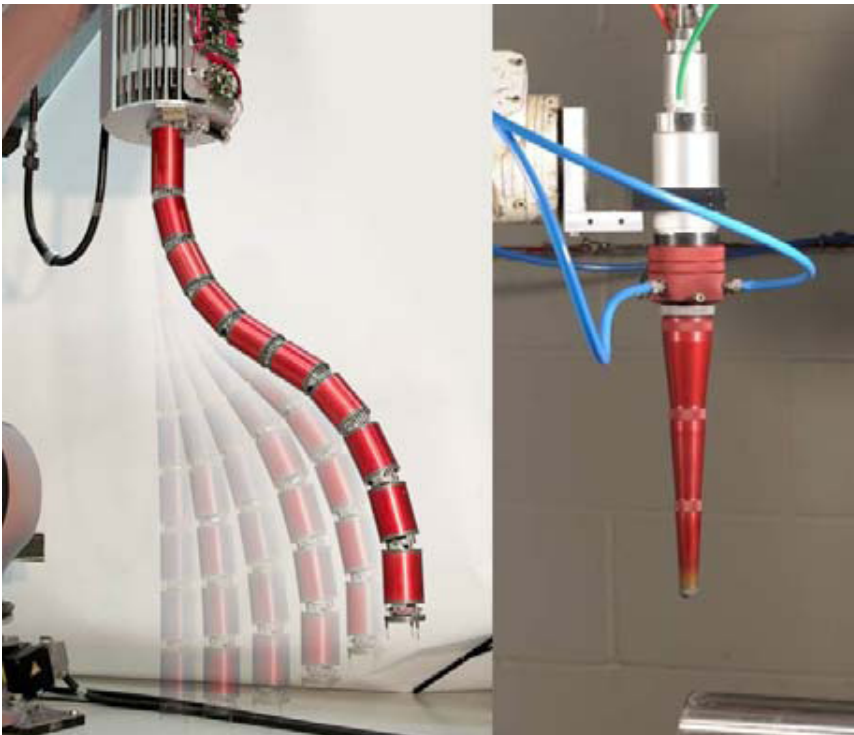

qfix robotics GmbH



Description of the company

qfix robotics GmbH was founded in 2004 and is located in Senden, Germany. It is a small enterprise developing, manufacturing and distributing mechatronics and robotics products especially for the educational market. The main product is the “qfix robot kits” family, a modular construction system for building autonomous mobile robots. The company works with global distributors, such as Conrad Electronic, Graupner, Christiani or Amazon.

**Erich-Rittinghaus-Strasse 2/2
89250 Senden
Germany
<http://www.qfix-robotics.com>
+49 7307 800321
enderle@qfix.de**

Range of products

qfix robot kits

The qfix robot kits are a modular construction system for building autonomous (mobile) robots. Typical users are schools, high-schools or mechatronics companies with their own training centers. Additionally, the kits or individual components are used in the hobby market. The system consists of mechanical elements, motors and sensors, controllers and electronics, and a programming environment with a specialized C++ library simple application of all components. The qfix robot kits stand out from well-known toy kits because of their professional orientation:

- mechanical elements are made of anodized aluminium,
- motors are regular DC-, stepper or servo motors,
- sensors cover the complete range of professional sensors,
- controller boards range from small boards with Atmel AVR controllers over ARM to Blackfin processors,
- software can either be implemented in C/C++ or LabVIEW Embedded can be used.

Differential Drive Platform

The Differential Drive Platform is a mobile robot platform for indoor and outdoor use. It is driven by a four-wheel differential drive with two powerful (90 or 150 W) Maxon motors. The platform can either be equipped with an onboard PC running Windows or Linux, or it comes with a CompactRIO system by National Instruments including two motor driver units, a digital I/O and an analog I/O unit. Depending on the choice of main controller, a number of additional equipment items can be selected:

- different distance sensors (laser, infrared, ultrasonic),
- different camera systems,
- GPS receiver,
- GSM/GPRS modem,
- Hokuyo laser range finder.

Typical users of this system are high-schools and universities performing their own more software-based experiments, such as navigation, path-planning, exploration, mapping, self-localization or human-robot interaction.



ROBOSOFT SA



Description of the company

Robosoft is a European leader in service robotics solutions. With over 20 years of recognized scientific and industrial expertise in this field, Robosoft has supplied advanced robotics solutions since 1985 in the transport, cleaning, security, health and research markets. Beyond professional applications, the era of personal robotics has now begun. Robosoft thinks that its service robots, known as "robuTERs®", will be part of everyday life within 5 years. RobuTERs will make everyone's lives easier in activities of leisure, education, culture, health, and in particular for the elderly and dependent. In order to provide these applications in daily life, Robosoft has developed its own software technology, known as robuBOX. This is already built into the heart of all robots made by Robosoft, but it can also be licensed to third party integrators or other robot manufacturers.

Technopole Izarbel
F-64210 BIDART
<http://www.robosoft.com>
+33 559 415 360
sales@robosoft.com

Range of products

robuCAR

The robuCAR product-line is built upon a robust 4 Wheel-drive / 4 Wheel-steer chassis. Thanks to its high payload, versions range from standard robotic platforms to advanced service robots and can be customized upon request or by customers. All vehicles are ready-to-use, with open software tools for developers.



robuROC

robuROCs are rugged off-road mobile platforms with good payload allowing any type of integration. While robuROC4 performs well in most harsh conditions, robuROC6 pushes boundaries thanks to its outstanding clearing capacities.



robuLAB

robuLABs are versatile indoor mobile robots with payloads ranging from 20 kg up to more than 100 kg. Versions range from standard platforms to advanced service robots and can be customized upon request or by customers. All robots are ready-to-use, with open software tools for developers.



robuARM

robuARM is a 6 D.O.F. with 10 kilos payload, designed to be integrated into mobile robots. It features an optional hi-end force torque sensor and fits many end-effectors.

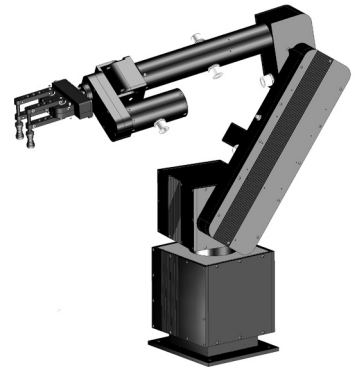

TO40

The TO40 is a fast positioning unit with pan, tilt, and verge degrees of freedom, allowing human-like works. It is smooth and precise enough for advanced vision processes with most off the shelves cameras.

Software

robuBOX, is a control system for service robots, that today powers all robots the company manufactures. robuBOX, a software toolbox dedicated to service robotics, works on three levels:

- PURE (Professional Universal Robot Engine) is the embedded real-time part, in which control laws are implemented.
- robuBOX-Services contains the business middleware. This is the customisable part of the robots and the reason why this package has been distributed as open-source since 2010. This middleware is developed in C#, using the Microsoft Robotics Developer Studio.
- Lokarria is the supervision layer for the robot or fleet of robots still under development. This layer is available on the internet in the form of "cloud services".

POOL (Pges Object-Oriented Layers), a software package used to implement simulators and Human Machine Interfaces. POOL leverages over 12 years of developments made by Robosoft-PGES in its "Vetronic" projects (electronic vehicles). POOL allows quick and easy development of multi-robot distributed applications with operators in the loop. POOL, which works on the principle of shared objects, manages at the same time:

- the structuring of objects,
- the distribution of data and commands between applications,
- maintaining consistency between applications,
- application/object independence,
- the transparent transition from "simulation" to "real" mode...
- POOL can also generate HMI (Human Machine Interface) graphics that combine 3D computer graphics, video and overlays for augmented reality.



ROBOX S.P.A.



Description of the company

Established in 1975, Robox S.p.A. has always been in the forefront of the industrial automation field. Since the beginning it has been specialized in the design and manufacturing of micro-computerized controllers for robots. Robox's expertise includes both motion control and on-line / off-line robot programming and path optimization. Robox's know-how is not limited to the robot itself, but includes also robots integration and robotized isle management. Since 1987, with the spreading of the Flexible Automation, Robox has exported its know-how to non-robotic applications. Its motion controllers are now employed to control the movement of any machine.

Despite its small dimensions Robox has played an active role in the industrial research: since 1990 Robox has been included in the Highly Specialized Research Laboratories authorized by the Italian Ministero dell'Istruzione, dell'Università e della Ricerca (Decreto Ministeriale 25.5.90) and it cooperates with Italian Universities in different automation researches. Robox is certified according to ISO 9001 with IMQ (now ISO 9001 :2008).

Via Sempione 82
28053 Castelletto Sopra Ticino
Italy
<http://www.robox.it>
+390331922086
sales@robox.it

Range of products

Modular and stand-alone motion controllers

These controllers have been designed to fit with any type of machine, from robots to machines for glass working, wood working, stone working, packaging, textile machines, etc.

The main features are:

- Up to 32 controlled axes
- Programming:
 - R (structured text language with motion libraries)
 - RPE (structured text language with robotics libraries)
 - Ladder (IEC1131)
 - ISO (interpreter of ISO sources generated by external CAD/CAM)
 - PLCopen function blocks library
 - OB, Object Blocks (extended concept of function block)
 - C++ allowing the programmer to design his own OB in order to create his own libraries
 - Libraries of the most common robotics structures
- RDE Programming suite
 - RDE is a programming suite designed to permit the best exploitation of Robox's programming languages. Besides allowing to write, compile and debug the application software, it permits to evaluate the behaviour of the controlled machine and therefore to choose the best solutions to optimize it.
 - It runs on personal computers with Windows 2000, XP, Vista, Linux (X11) or MAC OS/X platforms.
 - The controller is connected to the PC via serial/ethernet channels (TCP/IP).



Electronic controllers for inertial guided vehicles

The vehicle is controlled by a gyroscope able to measure its rotations around its vertical axis. Communication with the supervisor PC is obtained via radio. The movement is controlled by Robox's motion controllers .



Integrated motor drive for brushless motors

The SPIMD20 is a step forward in motion control. It offers a complete motor drive solution in a single, robust and reliable module (163,5x60x26mm 0,5 kg), including full bridge IGBT inverter, control unit and communication interface based on real-time industrial Ethernet. It is ready to be integrated in any brushless 3-phase motor up to 2 kW (i.e. 6.4 Nm @ 3000 rpm). The flexibility of the concept allows the use of the SPIMD20 as the first step in a motion distributed solution, implementing proprietary or open solutions. The architecture is suitable for the most common industrial safety standards.

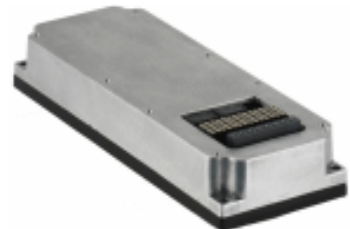

Rekno srl

REKNO robotics

Description of the company

REKNO designs, builds and sells integrated HW-SW modular robotic systems. Thanks to the REKNO-drive technology, the company is able to transform a generic mobile platform into a robot, able to autonomously navigate, localize and interact in indoor or outdoor environments. Customers can be provided with feasibility studies on customized robotic solutions, hereby benefiting from the early feasibility study on the integration of new robotic technologies in existing systems. Together with its own products, REKNO offers consulting services, training courses, and software for a wide range of robotic applications, customizing solutions according to customer's requirements.

**Via del Canaletto n. 101,
19125 La Spezia
Italy
<http://www.rekno.it>
+393492913512
info@rekno.it**

Range of products

REKNODrive (autonomous navigation system)

The REKNODrive is a complete, off-the-shelf, customizable UGV autopilot system, providing the customer ground vehicle with autonomous navigation features such as localization, obstacle avoidance and road following. The REKNODrive is based on a hybrid reactive/deliberative architecture which ensures an optimal combination of robustness and efficiency in dynamic environments. The REKNODrive is a set of software modules running on an embedded industrial PC board. The software suite includes, among others:

- Localization Module
- Obstacle Detection Module
- Vision Based Road Detection Module
- Autonomous Navigation Module
- Remote Graphical User Interface

Thanks to its modularity, each REKNODrive's software component can be purchased separately and easily integrated in pre-existing software architectures.

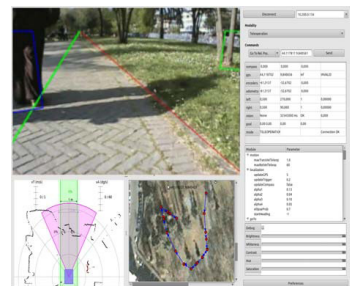
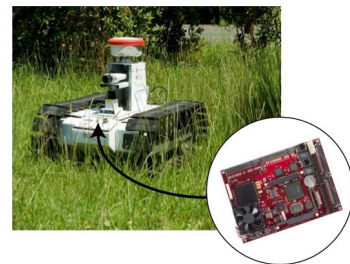

RoSc (Advanced 3D Laser Scanner Kit)

RoSc is a kit to transform every Robotic Arm in an Advanced 3D Laser Scanner. RoSc Kit is composed of a Triangulation Laser Profilometer (2) on the end-effector of the robot arm (1), and a Control Software installed on a powerful industrial PC (Intel multi-core system) (3). The system can be used as:

- Highly precise scanning system for realizing complete 3D CAD models of every kind of object
- Highly precise scanning system to perform machined piece comparisons with a 3D CAD reference model to assess defects in workmanship
- Highly precise evaluation of the position and orientation of a piece placed on a workbench before industrial processing, in order to adapt a planned robot arm trajectory

The kit can be fitted on every kind of robot arm as a standard tool. The software can communicate with standard robotic arm control systems.

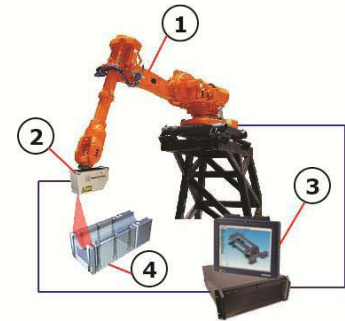

SafeEye (visual driving assistance system)

SafeEye is an effective visual-based driving assistance kit module for automotive applications. This system deals with the general safety issue of detecting dynamic obstacles on the road (e.g., rear-view camera system for blind spot monitoring and backing up). As a matter of fact, obstacles detection, especially moving objects detection, is the key component of any collision warning and avoidance system.

SafeEye is a modular kit which can be easily integrated in any vehicle and provides an easy way to increase the safety of the vehicle by giving the driver an effective situational awareness.

This kit is composed of wide-angle color cameras (mounted onboard of the vehicle), a processing unit and the user interface for the driver (e.g., digital display and audio sound alarm system). The system can be expanded by adding infrared cameras and ranging devices to improve detection accuracy.



ROBOTNIK AUTOMATION SLL



Description of the company

Robotnik is a company dedicated to automation and robotics engineering services as well as industrial machinery production and R&D project development. High-quality engineering services are offered on a national and an international level. The primary goal of Robotnik is to do a high-quality job concerning all its products and services. The main specialities are:

- Autonomous indoor transport robots and field service robotics applications.
- Robotics products (mobile robots, robot arms, robotic hands and humanoids).
- R&D Robotics projects and special robot system design.

This company won the "Jóvenes Emprendedores 2002 (Enterprising Youth Award)", given by "Fundación Bancaja", which recognizes the resourceful spirit of the company and the investment made in the development of products and services. It was also awarded the EIBT (Innovative and High-Tech Enterprise) qualification, by the ANCES National Network, which recognizes Robotnik as a high tech company, with an innovative environment and high professional and technological qualification.

BERNÍ Y CATALÁ, 53
46019 VALENCIA
Spain
<http://www.robotnik.es>
+34 963383835
jbosca@robotnik.es

Range of products

AGVS

AGVS is an autonomous mobile robot intended for indoor transportation tasks. AGVS is motorized by two motors controlling direction and traction. The robot has a low profile chassis, making it suitable for movement under hospital roller containers. The chassis, which is produced in aluminium and steel, carries the batteries, the motors and the mechanical transmissions, so as an electric axis to lift up and down the upper part of the robot. This part is able to carry up to 500 kg load. At both the rear and the front the robot has a navigation laser sensor for object detection. The robot is equipped with a mechanical braking system which acts in case of power loss or failure. The braking distance is calculated depending on the load conditions, velocity, slope, wheels waste or friction. The laser sensor adjusts the braking distance with the maximum load and velocity. The kinematic configuration of the robot allows the following of curves in an optimal way.



Tirant III

Tirant III[®] is a mobile robot capable of operating inside pipes to perform maintenance and inspection tasks. Tirant III[®] has been developed in collaboration with Grupo Dominguis and is world wide patented. It is used to spread liquid metal inside tube pipes of nuclear power plants.

The work performed by the robot was previously done by human operators in really harsh conditions. The melted metal was projected by hand, in reduced diameter tubes, where the operator had to wear protection clothes, gloves, glasses, or even autonomous breathing equipment. Tirant III[®] is the first generation of robots able to substitute humans in this kind of task. Grupo Dominguis has successfully realized metallizing services using this robot in several nuclear power plants with excellent results. The robot can modify its diameter to adapt automatically to the inputs and subsequently expanded to work on pipes of different diameters.



Rescuer

Rescuer is an extremely robust mobile platform and is appropriate for outdoor/indoor use, hazardous or difficult to access environments. This robot comes with a modular system, which allows to add user components. It has space for numerous accessory equipment whether on the platform or inside the robot. Rescuer is useful for all types of applications: from civil to scientific research and safety; even Civil Protection Agencies and Universities use Rescuer.



Guardian

Guardian is a modular robot with high mobility. It extends the range of missions in which the robotic technology is used in several ways:

- Teleoperation capabilities allow to remotely perform any mission, thus enhancing the security of the operator.
- The robot is small enough to be transported in a conventional car boot and light enough to be transported in a lift.

It requires a little control briefcase. The mobility and high speed of the robot allow it to rapidly access buildings.



Summit

The new mobile platform Summit has a high mobility and is suitable for both indoor and outdoor applications. It can easily overcome obstacles such as curbs and steps. The mechanical system is equivalent to a 4x4 remote control car and uses a high quality aluminium chassis. The robot can navigate autonomously, or can be teleoperated by using a PTZ camera (or its other advanced sensors: laser range finder, RTK-DGPS, inertial measurement unit, etc.) that transmits video in real time.

The control architecture is open-source and modular, based on Player/stage. This allows the programming and simulation of offline algorithmic and makes it extremely useful tool for teaching and research.



Modular Robotic Arm

The new modular robotic arms include modular servo-actuators. These actuators are composed of a motor-gearbox, a power stage and a controller, thus the resulting arm does not need an external control unit. Therefore, the communications between the arm and the external environment are reduced to the minimum wires: 2 for CAN bus and 2 for power. It is based on the original design by Budapest University of Technology and Economics Department of Manufacturing Science and Technology. The arm can be adjusted to the needed application requirements, thus it is possible to choose a conventional arm or to redesign the joining elements to fulfill the specific application needs.



Hydraulic Arm

The Hydraulic Robot Arm is designed for mobile manipulation applications, where high forces or the capacity to withstand collisions, or an IP68 level of protection is necessary. The Robot has been designed to work in hostile environments. Due to its robustness, it is especially suited to be mounted onto mobile platforms. The basic configuration is designed for teleoperation applications and does not integrate any feedback of the articulations. The servo configuration includes position feedback of the actuators. Both configurations are supplied with or without controller. The gripper and fingers may be switched for enhanced customization.

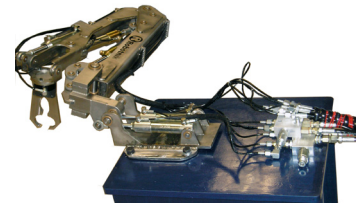

SCHUNK GmbH & Co. KG



Description of the company

SCHUNK is one of the largest manufacturers of Automation Components, Toolholders & Workholding Equipment. Its products - produced in 4 manufacturing facilities - are available worldwide. A dense network of distribution partners, customer-oriented chosen subsidiaries, exclusive master distributors and also our own Outside Technical Sales Engineers will assure support quality, precise know-how transfer, quick service and on-time deliveries. SCHUNK plays a leading role in modular robotics. Its philosophy "from the individual modules to the complex robot structure" creates the basis for the implementation of concepts in industrial and service robotics, which are designed for everyday life and are nevertheless efficient. With compact and flexibly combinable rotary actuators, lightweight manipulators and servo-electrically actuated grippers, approaches to unique and modular designed special solutions are offered. The goal is to provide robot modules for industrial and service applications which are flexible enough for the use in different robot applications.

Spann- und Greiftechnik
Bahnhofstrasse 106-134
74348 Lauffen am Neckar
Germany
<http://www.schunk-modular-robotics.com/>
+49 7133 103 2128
info@de.schunk.com

Range of products

PowerCube modules

SCHUNK is based on the new and unique concept of modular robotics. Individual and independent PowerCube modules (basic elements forming the lowest level of the system architecture such as joints, sensors ...) are provided with standardized interfaces for mechatronics and control, and their combination enables designing complex, flexible and reconfigurable robot systems. SCHUNK provides a wide variety of 24VDC actuators (including servo motors, rotary and linear modules, grippers ...) equipped with integrated high-end micro-controller and with fully integrated control, regulating and power electronics, as well as sensors. The innovative technology of the PowerCube modules is the basis for numerous applications in measuring and testing technology, laboratory automation, and service robotics and is firmly established in applied research, and flexible automation. Also, the accuracy of the motor current measurement in particular allows all components to be used in force adaptive applications.

Complex setups with several components:

Controllers

The control architecture is open and accessible at different levels. A crucial feature is the usage of inexpensive miniaturized hardware for the superior level of control (eg. Embedded PC or notebooks).

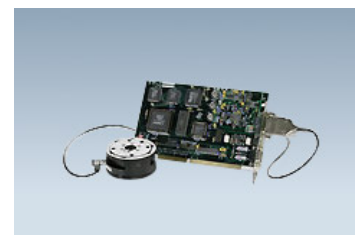

Combinations

The (independent) modules from the PowerCube series provide the basis for flexible combinations in automation. Integrated intelligence in the modules, universal communication interfaces (Profibus DP and CAN) and bus technology ensure a quick and simple integration into existing control concepts. Indeed, modules can be assembled with complete freedom and flexibility using connecting parts to produce an individual arm. Complex systems and multi-axis robot structures with many degrees of freedom can be realized with a minimum in design and programming expenditure. The following setups are just a few examples of kinematics often used. Depending on the application, kinematics can be assembled to fit the task. Also, modular robotics allows the customer to reconfigure the robot and reuse it for further applications.

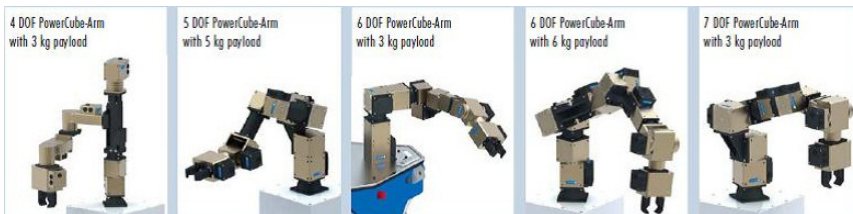

Lightweight PowerCube modules

In the concept of modular robotics, SCHUNK provides 24VDC lightweight PowerCube servo-electric rotary actuator modules, and as above their combination enables designing complex, flexible and reconfigurable robot systems. Thanks to the use of lightweight, high-strength materials, the compact rotary actuators achieve an intrinsic-weight/load-weight ratio better than 2:1. The power supply, control elements and universal communication interfaces are already integrated. These modules are designed for industrial automation as well as for service robotics. The focus is on the lightweight and 24VDC power input for mobile application.



Complex setups with several components:

Combinations

The individual PRL modules have flexible mounting possibilities to one individual light-weight arm using connecting elements. Also, special FT sensors can be integrated into the light-weight-arm hardware. It can be seen in some of these illustrations below the SCITOS G5 mobile platform bearing the SCHUNK robotic arm.



Robotic hands

Dextrous hands, such as the SDH-2 having three identical two-link fingers are also provided. Design and mobility of the fingers are modular to ensure that the components are available in modular systems in the future. Two of the fingers are movably coupled at the base and can rotate inversely by 90 degrees. The SDH-2 is, therefore, suitable for the industrial gripping types “three-finger centric”, “two-finger parallel” and “cylindrical grip”, in addition to many other variations. The link modules can generate torques of up to 2.1 Newton-Meters for the proximal link module and 1.4 Newton-Meters for the distal link module, which approximates the capabilities of the human hand. Six contact sensor fields are used for spatially resolved monitoring of the contact forces on the gripping surfaces. The hand can therefore identify diverse objects and can also reliably and sensitively grip similar parts of a part family. In reactive gripping, the hand uses sensors to detect whether an object is being held optimally or whether the grip has to be corrected. It is also able to position diverse objects and to join them for example. The intelligence of the SDH-2 is located in the “hand base“. The control strategy required for the respective gripping scenarios can be loaded as a decentral program module in the memory of the hand electronics. This makes the 3-finger hand a versatile robotics component.



Software and Support

Advanced research very much depends on completely open software architectures. This way, researchers can access control of the robotic equipment at different levels. Even at the low level motion control functions of the robotic joints the advanced user can parametrize the drive and retrieve real time data such as motor current, position, speed, voltage and temperature information.

SCHUNK provides specially designed application program interfaces (API) for different PC operation systems, namely LINUX and Windows. Software for LINUX is provided in open source fashion to enable the user to compile the libraries for different LINUX flavours. Other standard software equipment for data acquisition (e.g. LabView) is supported as well. Even industrial robot controllers (e.g. KEB) with handheld teaching pendants can be supplied with the SCHUNK robotic products.

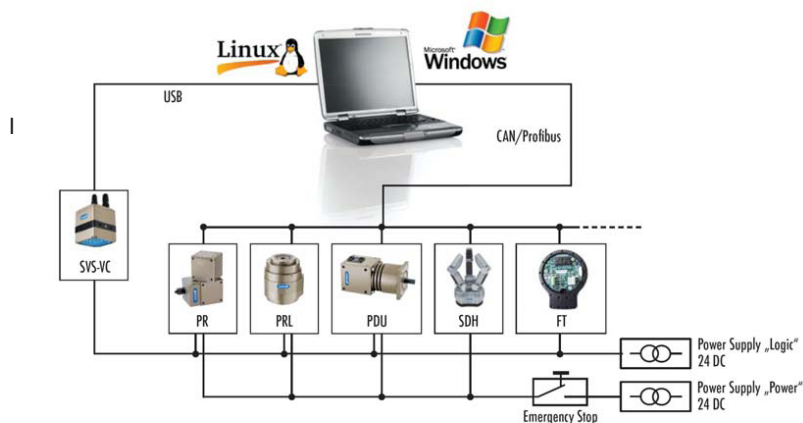

Robot-Control-Software and Standard Libraries

SERTEC



Description of the company

The Sertec engineering company began operating in Madrid in 1995. In the beginning, Sertec did Calculation and Finite Element Analysis for companies such as EADS-CASA Space Division. Then, Sertec hired expert design engineers versed in the use of CAD tools, primarily CATIA. This early work was done for the aerospace sector with the Eurofighter consortium, EADS-CASA, AIRBUS and ICSA. In parallel, Sertec worked closely on simulations with companies such as INDRA, EADS Simulation and TecnoBit. Subsequently, Sertec started working in the railway sector projects with CAF and Talgo. During the development of the two large European programs in the past decade, the Airbus A380 and Airbus Military A400M, Sertec has assisted in the final design and implementation of design modifications.

The creation of the Aerosertec group, born from the need to deliver "turnkey" projects to customers, including Engineering, Manufacturing and Assembly, allows Sertec to cover the entire range from raw material to final delivery, via machining, sheet metal bending, large-scale tooling and composite materials.

In recent years, Sertec has begun developing its own products, especially Missile and Aircraft Tracking Systems, Advanced Materials for Defense, Kits for Aircraft Upgrades and Modernization, etc. Sertec's future business line will continue to offer services through value-added engineering, unmanned vehicles, systems for defense and the knowledge of their engineers. Sertec's ambition in Research, Development and Innovation (R & D) has been realized in 2010 with the construction of its new Innovation Center in Getafe (Madrid).

As a turn-key project developing company, any kind of robotic platform, based on our client's specifications or requirements can be designed, manufactured and tested.

**c/ Morse, 3, P.I. San Marcos
28906 Getafe
Spain
<http://www.sertec.net/>
+34 917241775
eduardo.cano@sertec.net**

Range of products

PEM (Computer-vision based tracking platform)

A special platform use has been designed and developed in order to track high speed aircrafts. Its technology can be used in many kinds of applications, such as high speed obstacle avoidance systems or vision based navigation aids. It could be easily modified to accomplish any client's requirements, or to be used as a developing or laboratory computer vision platform.



LIRON

LIRON is a teleoperated ground vehicle. It has been designed as a platform to carry a wide kind of atmospheric sensors, to be used in dangerous or life-threatening situations or places, and to obtain as much information about the environment as possible. It can carry a robotic arm and gripper helped by cameras. It can manipulate, or pick, any object necessary for study. Currently, an autonomous control system for this robot is investigated. Similar to the rest of our designs, it can easily be modified to meet any special requirement.

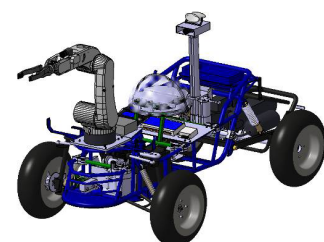

Skybotix AG



Description of the company

Skybotix AG is a spin-off of the Swiss Federal Institute of Technology Zurich (ETH), founded as a limited company. The Skybotix team is composed of highly qualified, world-class experts in aerial robotics and vehicle navigation, with several years of practical experience. Active in the field of Micro Aerial Vehicles, Skybotix develops aerial systems for different applications ranging from indoor reconnaissance and inspection of power plants to educational and scientific applications. The company now offers the CoaX[®] micro helicopter for scientific applications, a platform used by several renowned universities. Skybotix recently developed the FlyboX[™], an advanced control and navigation system for MAVs, used mainly on multi-copters. The company has active collaborations with renowned institutes such as ETHZ, EPFL, Univ. of Nice and several important com-

**c/o ETHZ, CLA E 17.1
Tannenstr. 3.
CH-8092 Zürich
Switzerland
<http://www.skybotix.com>
+41 44 632 89 06
info@skybotix.com**

Range of products

CoaX[™] Basic, Pack, eYe (Robotic coaxial helicopter)

CoaX[™] is a robotic coaxial helicopter designed as a suitable solution for research & education. It is a robot equipped with state of the art sensors and processors. The helicopter is equipped with two brushless motors for the main rotors and two servo motors for the swashplate-based steering. The CoaX[™] contains an integrated Inertial Measurement Unit (IMU), a pressure sensor, a downward-looking sonar, a three-side looking sonar (optional) and a color camera. There are two options for the camera. A standard color webcam that one can align manually so that it looks forward, sideward or downward, and a second camera option with a B/W high quality image with fisheye lens (150deg).

To communicate with the world, the robot has a Bluetooth (or ZigBee) module and an optional WiFi module. It can also be controlled via a 2.4GHz remote control. The CoaX[™] contains two DSPs. One is used for sensor data-fusion and the second one for control and communication. Additionally, the CoaX[™] supports the Overo[®] series of tiny computers from Gumstix[®] (optional). The CoaX[™] Overo[®] runs Ubuntu and R.O.S operating systems. CoaX[™] comes ready to fly out of the box with a set of attitude and altitude control functions. One can also control the system through an open-source API (included) to give high-level commands for taking-off, landing or any other type of motion. The users can simulate their algorithms on the provided simulator, and use exactly the same code to control the real helicopter.

Recently, Skybotix has also started to offer the CoaX[™] eYe, which allows the user to get the CoaX linear speed in X and Y in [m/s], with the speed control code included and open source. Using this module, the CoaX will thus be able to hover over a spot at a given height - even indoors.



Stäubli Robotics



Description of the company

Known worldwide for the quality of its methods and processes for over a century, the Stäubli Group has transferred its mechanical engineering know-how and its innovation to robotics. Since 1982, the development of the robotics business in the group has taken shape in the form of acquired competences and the development of new solutions. Today, Stäubli Robotics is a cutting-edge player in robotics around the world, with its engineering as effective and dependable as its sales and services.

Place Robert Stäubli
BP70
74210 Faverges
France
<http://www.staubli.com/robotics>
+33 4 50 65 62 87
robot.sales@staubli.com

Range of products

Stäubli TS, TX and RX robots (Robotic Arms)

The company provides a range of low, medium and heavy payload robots up to 250 kg including SCARA 4-axis robots, 6-axis robots and specialized robots dedicated for many industries (plastics, machine tools, life sciences, food, photovoltaics, semiconductor) and applications (painting, machining).

Complex setups with several components:

Robot controllers and software

Stäubli robots are controlled by a single control CS8 platform. It includes a comprehensive set of user-friendly yet powerful software solutions adapted for all:

- VAL products, ready to use market solutions,
- VAL3 language, advanced robotics environment to build high end and tailored applications,
- uniVAL drive, a “ready to plug” solution for machine builders to drive Stäubli robots with generic industrial motion controllers.

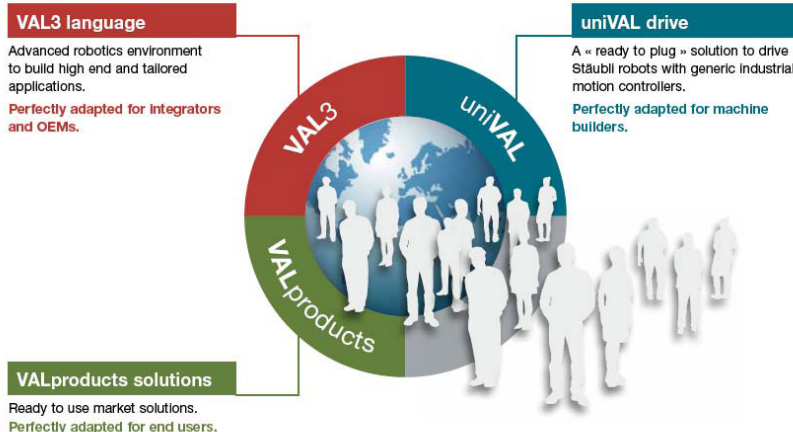

RX and TX robots are adapted for the needs of advanced research in laboratories. They feature an enclosed structure with an IP65 rating (wrist is IP67), making them adapted for use in a wide range of applications. Stäubli's RX and TX robots are also well-known for their precision and high reliability. They come in various models with a large range of reach (0.5 to 2.6 m) and payload (1 to 130 kg).

Several specialized versions are available to offer more possibilities to laboratories. "Cleanroom" versions come with intensified cleanliness even for ISO classes 2/3. "Stericlean" robots are designed for decontamination processes in VHP environments, replacing an operator in an isolator (glove box). The "he" robot range is optimized for use in humid environments. Interconnection cables are located underneath the arm for improved protection. The enclosed structure of the arm is reinforced by arm suppression or added water resistance.

On the software side, a Low Level Interface (LLI) option was designed specifically for advanced research laboratories. LLI provides a programming interface in C language to enable to fully reprogram motion algorithms, making it a completely open system for controlling a Stäubli robot arm.



Shadow Robot Company



Description of the company

Shadow is a British SME specialized in the development of advanced robotic hardware and systems. It has produced an advanced dextrous manipulation hardware for researchers. The Shadow team works with researchers to develop new hardware and software capabilities for their research, as well as working with industrial partners to take research outputs into new domains.

251 Liverpool Road
London, N1 1LX
United Kingdom
<http://www.shadowrobot.com>
+44 207 700 2487
contact@shadowrobot.com

Range of products

Shadow Dextrous Hand

The Shadow Dextrous Hand offers users 24 separate movements, controlled by 20 electric or 40 pneumatic actuators, with integral position sensing at all joints. It provides all the movements of the human hand in the same form factor, with a fully open interface permitting use from a range of external systems. Researchers use it to prototype brain-computer interfaces, to research grasping and manipulation, and to develop innovative service robots capable of the full range of tasks and applications of the human being.

Shadow has integrated the Dextrous Hand with a wide range of other robotic platforms. Customers have Shadow hands in use with Barrett WAMs, SCICOS arms, Mitsubishi PA-10s and even Willow Garage PR-2 mobile robots. The Dextrous Hand is controlled from an embedded host running Linux, which provides an open API for customer software. Additionally, a full interface to ROS is supported, with a native ROS simulation available for testing before running code on the real hardware.

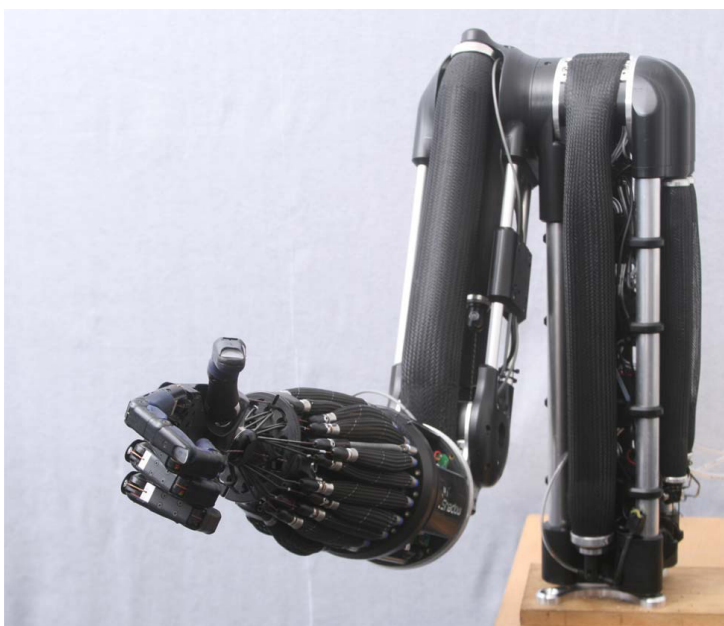
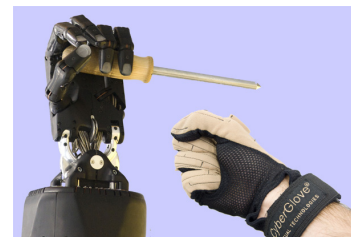

Index

Aerial robot: 8, 33, 73

Component/module: 39, 46, 68, 69

Controller: 8, 17, 21, 29, 36, 39, 57, 62, 69, 73, 74

Humanoid: 12, 33

Mobile manipulator: 10, 25, 27, 42, 54, 60

Mobile platform: 10, 14, 21, 33, 42, 43, 44, 49, 54, 59, 60, 66, 72

Multipode: 33

Navigation: 12, 14, 45, 49, 52, 64

Portal: 31

Robot arm/manipulator: 10, 17, 23, 25, 31, 39, 42, 57, 59, 66, 69, 74

Robot boat: 33

Robot hand: 23, 69, 76

Sensor: 23, 45, 64, 69

Software: 10, 12, 19, 20, 41, 39, 45, 49, 52, 54, 57, 60, 64, 69, 74, 76

Underwater robot: 29, 33

Publishing Information

© **ECHORD TUM 2011**

European Clearing House for Open Robotics Development

Technische Universität München (TUM)

Department of Informatics VI
Robotics and Embedded Systems

Boltzmannstr. 3
85748 Garching bei München, Germany

echord@in.tum.de
www.echord.info

All image copyrights are reserved by the respective companies.

ECHORD
European Clearing House for Open Robotics Development

Technische Universität München (TUM)

Department of Informatics VI
Robotics and Embedded Systems

Boltzmannstr. 3
85748 Garching bei München, Germany

echord@in.tum.de

www.echord.info